

Focus on electrophoresis

Fisherbrand, Fisher Chemical and Fisher Bioreagents working together to deliver reliable and essential products that meet your most demanding electrophoresis requirements



Meet the Fisher Scientific Family

Fisher Scientific's trusted, well established and proprietary product range, Fisherbrand is committed to providing quality products at affordable prices. Fisherbrand offers a broad selection of laboratory supplies and consumables covering a diverse range of applications such as chromatography, liquid handling, electrophoresis, pH and electrochemistry. It's the smart way to achieve cost savings over branded products without having to compromise on quality.



Watch our Meet the Family video to discover more



In addition to the extensive Fisherbrand range, Fisher Scientific is your partner of choice for chemicals and bioreagents. Fisher Chemical and Fisher Bioreagents deliver convenience, quality and consistency and are the leading provider of chemicals and bioreagents to many research sectors, such as academia, pharmaceuticals, biotechnology and healthcare.

- Fisher Chemical offers more than 4,000 chemicals of the highest quality including 'dry' reagents, ready made solutions and high purity solvents. All chemicals are ISO 9001:2008 certified and undergo rigorous quality assurance and testing procedures, ensuring excellent lot-to-lot and bottle-to-bottle consistency. Supported by a clear and simple grade and application structure, choosing the product that best suits your requirements is easy
- Fisher Bioreagents offers over 1,000 products dedicated to molecular biology research, biochemistry and cellular biology. It is your single source for high purity products

Fisherbrand[®]

F **Fisher
Chemical**

F
Fisher BioReagents[®]

Together Fisherbrand, Fisher Chemical and Fisher Bioreagents offer reliable and essential laboratory products, helping you to produce your best work each and every day.

New products are constantly being introduced into the Fisherbrand family.
For the full range visit www.eu.fishersci.com/fisherbrand

This application brochure is dedicated to providing you with a comprehensive overview of our electrophoresis portfolio as well as highlighting supplementary products from the Fisherbrand family. Featuring a range of instruments, consumables, Fisher Chemical and Fisher Bioreagents, as well as useful product resources such as formulas for producing your own stock solutions, troubleshooting guides, FAQ's and workflows, it is a great lab companion.



Watch our Focus on Electrophoresis video to discover more



Fisherbrand[®]

**Fisher
Chemical**

F
Fisher BioReagents[®]

For a fuller range of Fisher Chemical and Fisher Bioreagents, please refer to our Laboratory Reagents handbook. This handbook features

For the life scientist:

- A dedicated section relating to four key application areas

- Protein Chemistry
- Molecular Biology
- Cell Biology
- Core Bioreagents

For the analytical chemist

- Over 4400 Fisher Chemical products dedicated to many analytical applications, including Optima LC/MS grade solvents and high purity acids for Trace Elemental analysis

- Colour coded application
- Physical & chemical data
- Hazard, packaging and storage information
- Detailed specifications

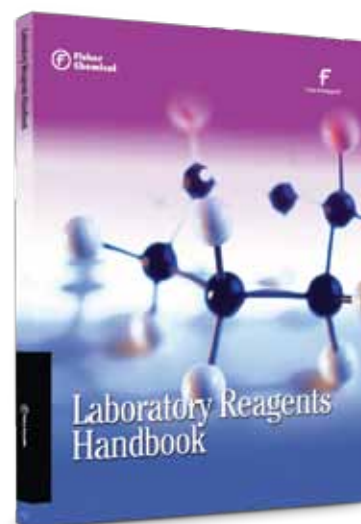

To order your copy visit www.eu.fishersci.com/catalogues

HORIZONTAL GEL ELECTROPHORESIS	6
• Focus on Genomics Workflow	6
• Introduction to Horizontal Gel Electrophoresis	8
• Horizontal Gel Units	9
- Horizontal Gel Units, SUB-GEL	9
SUB-GEL Mini	11
SUB-GEL Midi	12
SUB-GEL Midi-Plus	13
SUB-GEL Maxi	14
- Horizontal Gel Units, Wide Format	15
Wide Format, Mini-Plus	15
Wide Format, Midi-Plus	15
• Fisher Bioreagents for Horizontal Gel Electrophoresis	16
- Agarose	16
- Buffers for Horizontal DNA Electrophoresis	16
- Buffer Components for Horizontal DNA Electrophoresis	16
- Buffer for Horizontal RNA Electrophoresis	17
- Sample Loading Dyes	17
- DNA Visualisation	17
- DNA Ladders	17
- Other Bioreagents	17
• Producing your own stock solutions for Horizontal Gel Electrophoresis	18-19
• Technical Resources	20
- Horizontal Gel Unit Troubleshooting Guide	20-21
- Frequently Asked Questions (FAQ's) – Horizontal Gel Electrophoresis	22
VERTICAL GEL ELECTROPHORESIS	24
• Focus on Proteomics Workflow	24
• Introduction to Vertical Gel Electrophoresis	27
• Vertical Gel Units	28
- The Verti-Gel Mini system	28-29
Verti-Gel Mini, 2-Gel System (Standard)	30
Verti-Gel Mini, 4-Gel System (Tetrad)	30
- Vertical Gel Unit, Verti-Gel Maxi	32-33
Verti-Gel Maxi, 2-Gel System (Standard)	34
• Fisher Bioreagents for Vertical Gel Electrophoresis	35
- EZ-Run Protein Gel Solution	35
- EZ-Run Protein Standards Solution	36
- EZ-Run Protein Gel Staining Solution	36
- Buffers for Protein Electrophoresis	37
- Acrylamide, Bis-Acrylamide and Catalysts	37
- Detergents/Denaturing Reagents	37

- **Producing your own stock solutions for Vertical Gel Electrophoresis** 38-39
- **Blotting** 40
 - Semi Dry blotter 40
 - Slab Gel Dryers 40
 - Vacuum System for Gel Dryers 40
- **Technical Resources** 41
 - Vertical Gel Unit Troubleshooting Guide 41-42
 - Frequently Asked Questions (FAQ's) – Vertical Gel Electrophoresis 43-45

POWER SUPPLIES 46

- **Power Supplies in Electrophoresis** 46
- **Power Supplies Selection Guide** 46
- **Power Supplies** 47
 - Mini 300V Plus and Midi 300V/4 47
 - Mini 300V Plus 47
 - Midi 300V/4 47
 - Power supply models 300, 350, 608, 3000 48
 - Power Supply 300 48
 - Power Supply 350 48
 - Power Supply 608 48
 - Power Supply 3000 48
 - Power supply model 9003P 49
- **Technical Resources** 50
 - Power Supplies Troubleshooting Guide 50
 - Frequently Asked Questions (FAQ's) – Power Supplies 51

FISHERBRAND SUPPLEMENT 52

- **Centrifugation** 52
- **Chromatography** 54
- **Cryogenics** 54
- **Glassware** 55
- **Liquid handling** 56
- **Microplates** 58
- **Mixing** 59
- **pH and electrochemistry** 61
- **Plasticware** 63
- **Safety** 65
- **Temperature maintenance** 66

FOCUS ON GENOMICS WORKFLOW

Depend on Fisherbrand, Fisher Chemical and Fisher Bioreagents to provide products for every step of your Genomics workflow.

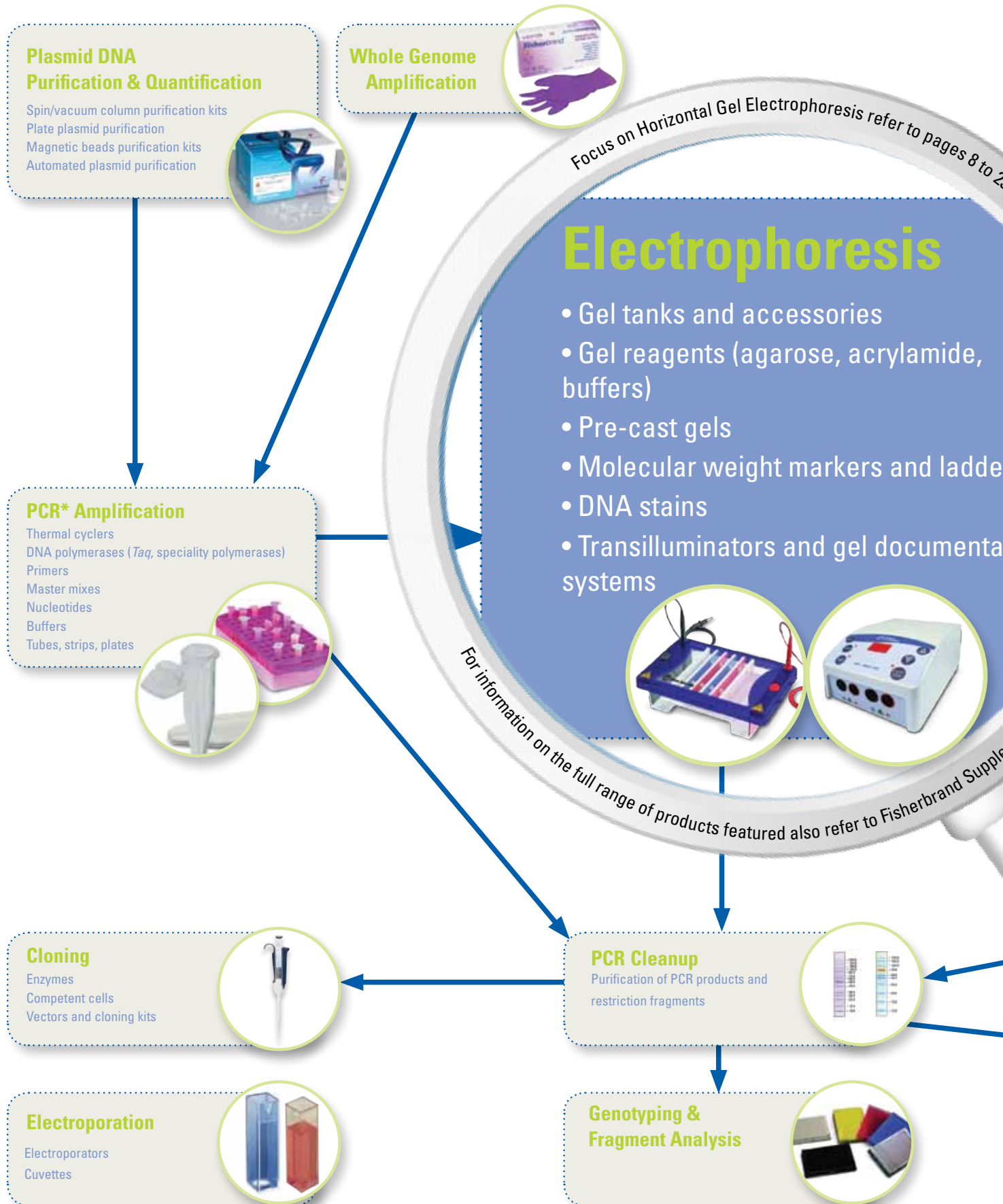

Genomic DNA Purification

- Spin column purification kits
- Plate purification kits
- Magnetic beads purification kits
- Organic purification reagents
- Automated genomic DNA purification



RNA Purification & Quantification

- Spin column purification kits
- Plate RNA purification kits
- Magnetic beads purification kits
- Total RNA, mRNA, small RNA purification kits
- Ribosomal RNA depletion kits
- Organic purification reagents
- Automated RNA purification



Southern Blotting

- Membranes
- Buffers
- Probe synthesis and labelling kits
- Detection reagents
- Films and cassettes
- Imaging systems



In vitro Translation



Northern Blotting

- Membranes
- Buffers
- Probe synthesis and labelling kits
- Detection reagents
- Films and cassettes
- Imaging systems



RT-PCR, qPCR Amplification

- Stand-alone RT reagents
- RT-PCR kits
- qPCR and qRT-PCR kits
- Custom, predesigned and validated assays
- SYBR Green and probe-based detection



Microarrays

- Slides
- Buffers
- Probe synthesis and labelling kits
- Array CGH labelling systems
- RNA amplification kits

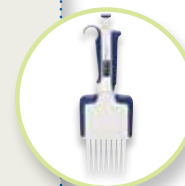

*Polymerase Chain Reaction (PCR) is a process covered by patents owned by Hoffmann-La Roche

INTRODUCTION TO HORIZONTAL GEL ELECTROPHORESIS

Although a long established technique, horizontal gel electrophoresis offers many advantages for nucleic acid separation and remains today one of the mainstays of molecular biology. It is an analytical technique used to separate DNA or RNA molecules based on size. Samples are loaded into wells of an agarose gel, which is submerged in an electrophoresis unit containing buffer, and subjected to an electric field. Due to the net negative charge of the DNA/RNA molecule, applying the electric current induces it to migrate towards the anode. Separation is achieved within the gel matrix as larger molecules migrate slowly and remain near the cathode, whilst smaller molecules experience less resistance within the gel and migrate towards the anode.

This section provides an overview of the range of Fisherbrand horizontal gel units, which is one of the most comprehensive and versatile ranges currently available for low and high throughput DNA and RNA applications. It also features Fisherbrand power supplies as well as essential Fisher Bioreagents, such as agaroses, buffers and DNA visualisation agents.

To view the instruction manuals for the following range of horizontal gel units visit www.eu.fishersci.com/fisherbrand.

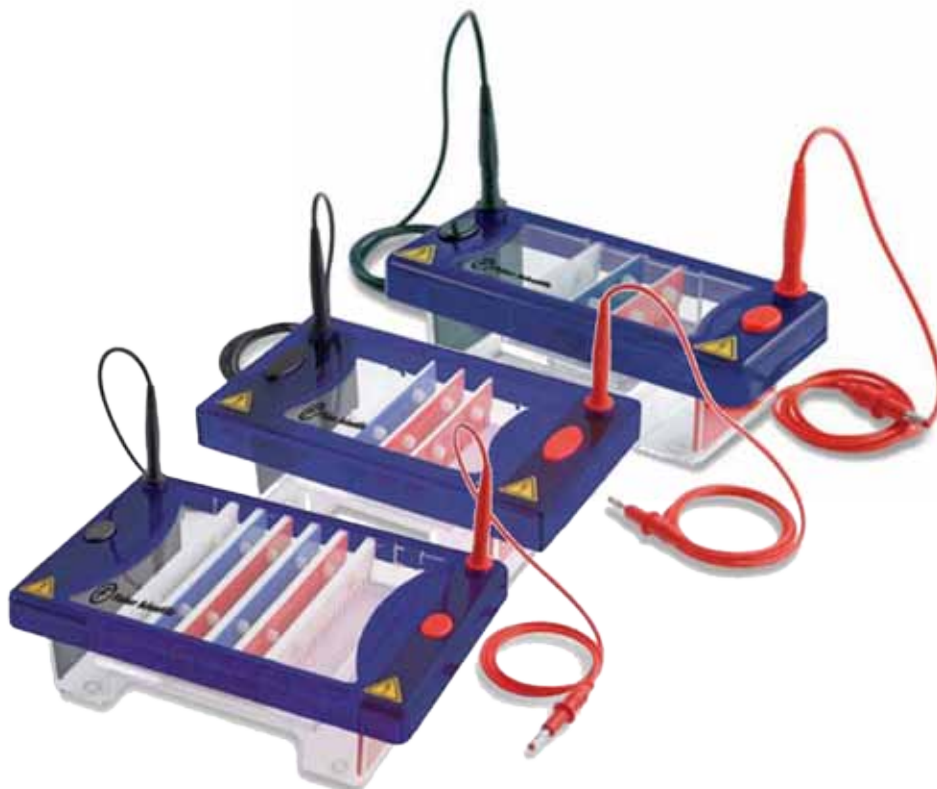

HORIZONTAL GEL UNITS

Horizontal Gel Units, SUB-GEL

The Fisherbrand SUB-GEL range features Mini, Midi, Midi-Plus and Maxi units. The relatively compact size of each unit results in economical buffer and gel consumption without compromising resolution and separation speed.

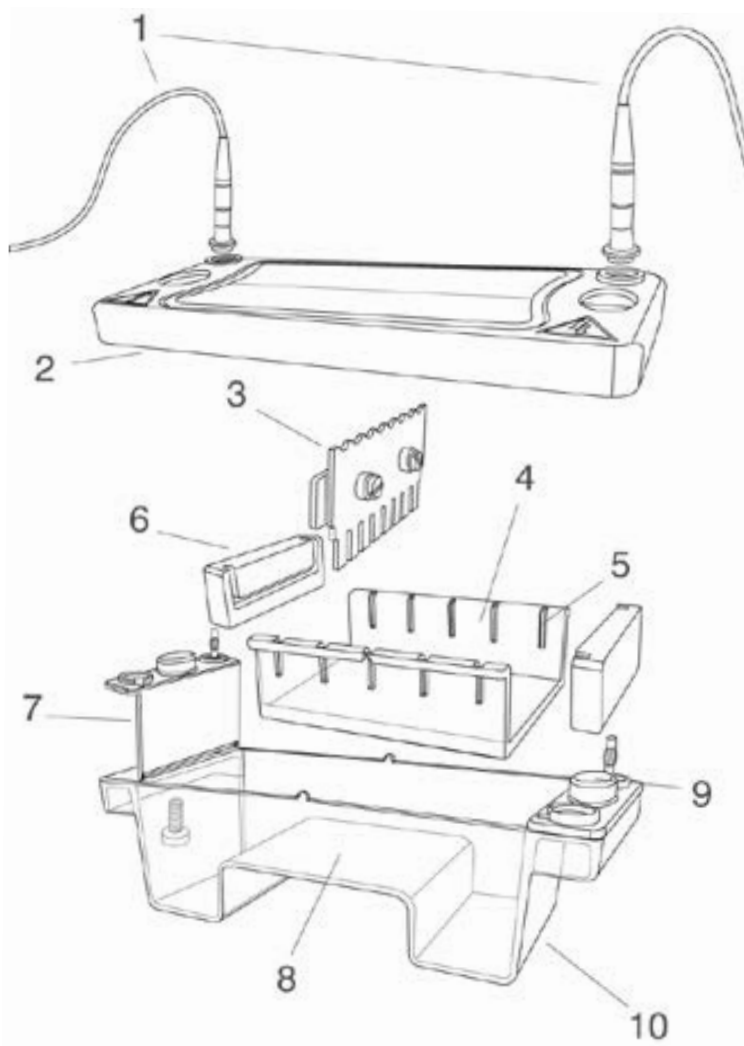

Components of the SUB-GEL Mini gel tank

- 1 Power cables
- 2 Safety lid & viewing pane
- 3 Height-adjustable comb
- 4 UV transparent gel tray
- 5 Comb slots
- 6 'Plug-and-Go' casting dams
- 7 Colour coded electrodes with power plug connectors
- 8 Gel platform
- 9 Safety lid thumb locators
- 10 Moulded tank

Horizontal Gel Electrophoresis

TANK AND LID DESIGN	
	High quality injection moulded construction and durable leak-proof design for complete safety and longevity
	Cassette-style electrodes – difficult to break, but inexpensive and easy to change – composed of 99.99% corrosion resistant, pure platinum
	Electrical safety – lid removal immediately disconnects power to the lower buffer chamber to allow entirely safe access to the gel
	Easy-click lid removal – asymmetric lid design and thumb locators on colour coded cassette-style electrodes ensure that electrophoresis is always performed in the correct polar direction – i.e. negative to positive
COMBS	
	The widest range of combs available - fit virtually every application from preparatory electrophoresis to high throughput screening
	Available in four thicknesses and colour coded. Range from: <ul style="list-style-type: none"> • White – 1mm supplied as standard • Black – 0.75mm for tightly resolved bands • Red – 1.5mm to maximise sample volume • Blue – 2mm to maximise sample volume Black and white combs recommended for high resolution gels and publication quality data; red and blue to scale-up nucleic acid volumes for preparatory techniques
	Height adjustable, without any requirement for specialist tools or comb holders, to give user full control over well depth and sample loading volume; rigid comb back prevents heat-induced warping
	Reversible loading guides sit directly above each well to provide a convenient loading template for single and multichannel pipettors
TRAYS	
	Multiple gel tray options – eliminate the need for additional gel tanks and allow gels to be cast externally, keeping the tank permanently in use for electrophoresis if required
	UV and blue light transparent
CASTING	
	'Plug-and-Go' casting – moulded casting dams clip easily onto the ends of the gel tray for rapid external casting Casting is as simple as 1, 2, 3... (1) Simply place one dam onto the lab bench facing upwards and insert the tray into the groove in the dam (2) Repeat with the second dam at the other end (3) The tray is now sealed and may be placed on flat bench space or gel levelling table in readiness for leak proof gel-casting
	Other casting options include flexicaster and plastic casting gates
ACCESSORIES	
	<ul style="list-style-type: none"> • Red loading guides – aid well and sample visualisation during loading • White gel platform – provides a contrasting background to view bromophenol blue migration fronts and determine electrophoresis progress during every run
	Gel levelling table. Adjustable levelling feet used in conjunction with a levelling bubble provide an even surface upon which to pour wide and large format gels, to ensure consistent and uniform migration
	runFAST cool pack and platform – sit directly above the gel in the buffer to provide enhanced resolution and faster run times; especially suited to larger format horizontals. To use: (1) fill the tank with buffer and load samples (2) insert platform above the gel (3) place pre-frozen cool pack onto platform; connect to power supply and run samples at higher voltage
	<ul style="list-style-type: none"> • Power cables – with 4mm connectors compatible with most modern low-to-medium voltage power supplies; CE compliant. Adapters available for complete power supply compatibility • Buffer Saver Blocks – conserve buffer for added economy – especially beneficial in larger format units

SUB-GEL Mini

Designed for quick checks of low to medium numbers of samples.

- Supplied with 70mm x 70mm and 70mm x 100mm gel trays
- Economic low gel and buffer volumes
- Small footprint
- Injection moulded

Technical Specification

Dimensions [l x w], mm	70 x 70, 100 x 70 (gel)
Dimensions [l x w x h], mm	210 x 90 x 90 (unit)
Capacity	32 samples (max., 70mm x 70mm tray)
	64 samples (max., 70mm x 100mm tray)
Volume, mL	225 (buffer)
Combs	
- No. of samples	1, 2, 4, 8MC, 8, 10, 12MC, 16
- Thickness, mm	0.75, 1, 1.5, 2

MC = Multichannel pipettor compatible

Cat. No	Description
11863303	SUB-GEL Mini



Combs and Accessories

Combs	Thickness 0.75mm		Thickness 1.0mm		Thickness 1.5mm		Thickness 2.0mm	
	Cat. No	Sample size, μL	Cat. No	Sample size, μL	Cat. No	Sample size, μL	Cat. No	Sample size, μL
Prep 1, Marker 1	11873473	152	11823483	203	11833483	304	11843483	405
Prep 2, Marker 2	11833493	68	11843493	90	11857553	135	11867553	180
Prep 4, Marker 2	11877553	36	11887553	48	11897553	72	11807563	96
8 sample, MC	11857563	8	11867563	11	11877563	17	11887563	23
8 sample	11817563	19	11827563	25	11837563	37	11847563	50
10 sample	11883473	14	11893473	18	11803483	27	11813483	36
12 sample, MC	11853483	10	11863483	14	11873483	20	11883483	27
16 sample	11893483	7	11803493	10	11813493	15	11823493	20

Cat. No	Description
Accessories	
11847573	UV tray 70mm x 70mm
11837573	UV tray 100mm x 70mm
11837633	Casting dams
11863473	SUB-GEL Mini/Midi Flexi caster
11897563	Adhesive loading guides
11867573	Viewing platform
11807583	Cool-pack and platform
11877633	Buffer saver blocks (x 2)
11857573	UV gel scoop, 70mm

Horizontal Gel Electrophoresis

SUB-GEL Midi

Ideal for quick checks of samples from PCR* and cloning.

- Run up to 100 samples
- Low buffer volumes
- Ideal for rapid electrophoresis
- Injection moulded

Technical Specification

Dimensions [l x w], mm	70 x 100, 100 x 100 (gel)
Dimensions [l x w x h], mm	220 x 125 x 90 (unit)
Capacity	50 samples (100mm x 70mm tray, max.)
	100 samples (100mm x 100mm tray, max.)
Volume, mL	300 (buffer)
Combs	
- No. of samples	1, 2, 4, 8, 10MC, 12, 16, 20MC, 25
- Thickness, mm	0.75, 1, 1.5, 2

MC = Multichannel pipettor compatible

Cat. No	Description
11853303	SUB-GEL Midi

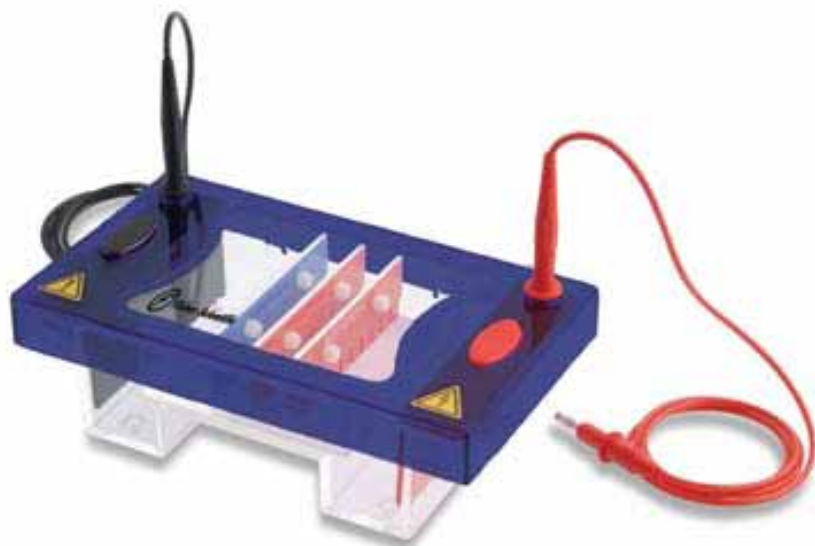

Combs and Accessories

Combs	Thickness 0.75mm		Thickness 1.0mm		Thickness 1.5mm		Thickness 2.0mm	
	Cat. No	Sample size, µL	Cat. No	Sample size, µL	Cat. No	Sample size, µL	Cat. No	Sample size, µL
Prep 1, Marker 1	11883303	270	11833313	360	11843313	540	11853313	720
Prep 2, Marker 2	11843323	118	11893323	158	11803333	236	11813333	315
Prep 4, Marker 2	11863333	57	11873333	77	11883333	115	11893333	153
8 sample	11803343	30	11813343	41	11823343	61	11813353	81
10 sample MC	11893303	20	11803313	27	11813313	41	11823313	54
12 sample	11863313	17	11873313	23	11883313	34	11893313	45
16 sample	11803323	12	11813323	16	11823323	24	11833323	32
20 sample MC	11853323	10	11863323	14	11873323	20	11883323	27
25 sample	11823333	7	11833333	10	11843333	15	11853333	20

Cat. No	Description
Accessories	
11873353	UV tray 70mm x 100mm
11863353	UV tray 100mm x 100mm
11807633	Casting dams
11863473	SUB-GEL Mini/Midi Flexi caster
11823353	Adhesive loading guides
11803363	Viewing platform
11897573	Cool-pack and platform
11867633	Buffer saver blocks (x 2)
11893353	UV gel scoop, 100mm

*Polymerase Chain Reaction (PCR) is a process covered by patents owned by Hoffmann-La Roche

SUB-GEL Midi-Plus

Ideal for restriction fragment analysis, sample prep or checking high numbers of samples.

- Run up to 210 samples
- Low buffer volumes
- Multichannel pipettor compatible combs for fast gel loading
- Injection moulded

Technical Specification

Dimensions [l x w], mm	70 x 150, 100 x 150, 150 x 150 (gel)
Dimensions [l x w x h], mm	265 x 175 x 90 (unit)
Capacity	70 samples, max. (70mm x 150mm tray)
	140 samples, max. (100mm x 150mm tray)
	210 samples, max. (150mm x 150mm tray)
Volume, mL	500 (buffer)
Combs	
- No. of samples	1, 2, 4, 10, 10MC, 12, 14MC, 16, 18MC, 20, 28MC, 30MC, 35
- Thickness, mm	0.75, 1, 1.5, 2

MC = Multichannel pipettor compatible

Cat. No	Description
11833293	SUB-GEL Midi-Plus



Combs and Accessories

Combs	Thickness 0.75mm		Thickness 1.0mm		Thickness 1.5mm		Thickness 2.0mm	
	Cat. No	Sample size, µL	Cat. No	Sample size, µL	Cat. No	Sample size, µL	Cat. No	Sample size, µL
Prep 1, Marker 1	11823363	371	11813373	495	11823373	743	11833373	990
Prep 2, Marker 2	11803393	169	11853393	225	11863393	338	11873393	450
Prep 4, Marker 2	11803413	91	11813413	122	11823413	182	11833413	243
10 sample	11833363	34	11843363	45	11853363	68	11863363	90
10 sample, MC	11873363	22	11883363	29	11893363	44	11803373	59
12 sample	11843373	30	11853373	41	11863373	61	11873373	81
14 sample, MC	11883373	22	11893373	29	11803383	44	11813383	59
16 sample, MC	11823383	20	11833383	27	11843383	41	11853383	54
18 sample, MC	11863383	8	11873383	11	11883383	17	11893383	23
20 sample	11813393	16	11823393	21	11833393	32	11843393	43
28 sample, MC	11883393	8	11893393	11	11803403	17	11813403	23
30 sample, MC	11823403	9	11833403	13	11843403	19	11853403	25
35 sample	11863403	7	11873403	10	11883403	15	11893403	20

Cat. No	Description
Accessories	
11803423	UV tray 70mm x 150mm
11883413	UV tray 100mm x 150mm
11893413	UV tray 150mm x 150mm
11817633	Casting dams
11813363	SUB-GEL Midi-Plus/Maxi Flexi caster
11823423	Adhesive loading guides
11843413	Viewing platform
11877573	Cool-pack and platform
11847633	Buffer saver blocks (x 2)
11813423	UV gel scoop, 150mm

Horizontal Gel Electrophoresis

SUB-GEL Maxi

Primarily designed for separating high numbers of samples from PCR* or cloning.

- Supplied with 200mm x 100mm and 200mm x 200mm gel trays. 200mm x 250mm is also available
- Run up to 550 samples
- Low buffer volumes
- Ideal for extended separations
- Injection moulded

Technical Specification

Dimensions [l x w], mm	100 x 200, 200 x 200 (gel)
Dimensions [l x w x h], mm	395 x 230 x 90 (unit)
Capacity	200 samples, max. (200mm x 100mm tray)
	450 samples, max. (200mm x 200mm tray)
	550 samples, max. (200mm x 250mm tray)
Volume, mL	1,200 (buffer)
Combs	
- No. of samples	1, 2, 4, 10, 16, 20MC, 25, 30, 36, 40MC, 50
- Thickness, mm	0.75, 1, 1.5, 2

MC = Multichannel pipettor compatible

Cat. No	Description
11843303	SUB-GEL Maxi



Combs and Accessories

Combs	Thickness 0.75mm		Thickness 1.0mm		Thickness 1.5mm		Thickness 2.0mm	
	Cat. No	Sample size, µL	Cat. No	Sample size, µL	Cat. No	Sample size, µL	Cat. No	Sample size, µL
Prep 1, Marker 1	11833423	508	11883423	675	11893423	1,013	11803433	1,350
Prep 2, Marker 2	11853433	236	11803443	315	11813443	473	11823443	630
Prep 4, Marker 2	11853453	115	11803463	153	11813463	230	11823463	306
10 sample	11843423	54	11853423	72	11863423	108	11873423	144
16 sample	11813433	30	11823433	41	11833433	61	11843433	81
20 sample, MC	11863433	20	11873433	27	11883433	41	11893433	54
25 sample	11833443	16	11843443	21	11853443	32	11863443	42
30 sample	11873443	13	11883443	17	11893443	26	11803453	34
36 sample	11813453	11	11823453	14	11833453	22	11843453	29
40 sample, MC	11863453	8	11873453	11	11883453	17	11893453	23
50 sample	11833463	8	11843463	10	11853463	16	11863463	21

Cat. No	Description
Accessories	
11813473	UV tray 200mm x 100mm
11823473	UV tray 200mm x 200mm
11833473	UV tray 200mm x 250mm
11827633	Casting dams
11813363	SUB-GEL Midi-Plus/Maxi Flexi caster
11873463	Adhesive loading guides
11853473	Viewing platform
11887573	Cool-pack and platform
11857633	Buffer saver blocks (x 2)
11843473	UV gel scoop, 200mm

*Polymerase Chain Reaction (PCR) is a process covered by patents owned by Hoffmann-La Roche

Horizontal Gel Units, Wide Format

The Fisherbrand horizontal wide format gel units are ideal for the screening and analysis of a wide range of samples including PCR products, DNA mini-preps, plasmid vectors and restriction fragments. They allow a greater number of samples to be run on one gel without compromising sample volume.

Wide format, Mini-Plus

For routine, rapid electrophoresis.



- Gel dimensions: 102mm x 144mm (l x w)
- Buffer volume: 500mL
- Maximum number of samples: 80
- Removable gel casting tray

Features four comb positions for the faster separation of multiple samples
MC = Multichannel pipettor compatible

Cat. No	Description
11553352	Includes: Gel unit, wide format, Mini-Plus, 1 x gel casting tray with gates, 2 x 1.0mm 20 sample combs, power supply connectors and loading strips

Wide format, Midi-Plus

For both analytical and preparative studies of nucleic acids.



- Gel dimensions: 140mm x 230mm (l x w)
- Buffer volume: 800mL
- Maximum number samples: 200
- Removable gel casting tray

Features four comb positions for the faster separation of multiple samples with the benefit of optional buffer recirculation ports
MC = Multichannel pipettor compatible

Cat. No	Description
11563382	Includes: Gel unit, wide format, Midi-Plus, 1 x gel casting tray, 2 x 1.0mm 16 sample combs, buffer recirculation ports, power supply connectors and loading strips

Combs and Accessories

Combs	Thickness 1.0mm		Thickness 1.5mm		Thickness 2.0mm	
	Cat. No	Sample size, µL	Cat. No	Sample size, µL	Cat. No	Sample size, µL
4 sample	11523362	42	11503372	213	11583372	284
8 sample, MC	11533362	67	11513372	100	11593372	133
10 sample	11543362	52	11523372	77	11503382	103
12 sample	11553362	40	11533372	61	11513382	81
16 sample, MC	11563362	29	11543372	44	11523382	58
20 sample	11573362	22	11553372	32	11533382	43

Cat. No	Description
Accessories	
11563352	Gel casting tray
11573352	Silicone casting gates, pack of 2
11583352	Silicone gasket 1m

Combs and Accessories

Combs	Thickness 1.0mm		Thickness 1.5mm		Thickness 2.0mm	
	Cat. No	Sample size, µL	Cat. No	Sample size, µL	Cat. No	Sample size, µL
12 sample, MC	11523392	72	11593392	108	11563402	144
16 sample	11533392	52	11503402	78	11573402	104
20 sample	11543392	40	11513402	60	11583402	80
25 sample, MC	11553392	30	11523402	45	11593402	60
28 sample	11563392	26	11533402	39	11503412	52
40 sample	11573392	17	11543402	25	11513412	34
50 sample, MC	11583392	15	11553402	23	11523412	30

Cat. No	Description
Accessories	
11573382	Gel casting tray, 100mm x 230mm
11583382	Gel casting tray, 140mm x 230mm
11503392	Silicone casting gates, pack of 2
11583352	Silicone gasket 1m

Don't forget your power supplies, these can be found on page 46 to 49



FISHER BIOREAGENTS FOR HORIZONTAL GEL ELECTROPHORESIS

From buffer solutions which act to reduce pH changes and over-heating of the gel, to DNA ladders for accurate estimation of fragment size and visualisation agents such as ethidium bromide, this section is designed to help you select the right bioreagent for your horizontal gel electrophoresis research. Fisherbrand and Fisher Bioreagents working together to deliver an end-to-end package that can meet your most demanding electrophoresis requirements.

Agarose



Agarose is a linear polysaccharide composed of alternating residues of D- and L-galactose joined by glycosidic linkages. Agarose forms gels that are both porous and resilient. These gel properties provide a sieving matrix which allows the electrophoretic separation of charged macromolecules such as DNA or RNA according to size. Compared to polyacrylamide gel, agarose has a lower resolution but wider range of separation. Using poor grades of agarose for gel production runs the risk of contamination with other polysaccharides, salts, and proteins. Such impurities can alter the gelling/melting temperature of agarose solutions or affect the ability to use the recovered nucleic acid sample in a post-electrophoresis application.

Fisher Bioreagents offers three different grades of agarose that are functionally tested and pre-qualified for specific applications.

- **Genetic Analysis Grade:** agarose that yields biologically active DNA or RNA. Testing includes enzymatic performance measurements
- **Molecular Biology Grade:** suitable for analytical separation of DNA or RNA
- **PCR* Grade:** the original agarose for analytical separation of PCR amplicons (<1kb)

Agarose grade	Molecular Biology	Molecular Biology	Genetic Analysis	Genetic Analysis	PCR Grade
Type of Agarose	Low EEO	Low Melting (>200bp)	Low Melting (<1kb)	Wide Separation Range	PCR Grade
Cat. No	10766834 (100g)	10377033 (25g)	10583355 (100g)	10688973 (100g)	10522775 (100g)
	10366603 (500g)			10776644 (500g)	
Recovery of DNA or RNA	•	•	•	•	•
Southern and Northern blots	•				
DNA/RNA separation 50bp to 1kb			•		•
DNA/RNA separation >1kb	•	•		•	
PCR fragment analysis	•	•	•	•	•
In-gel reactions (ligation, transformations, PCR)			•		
Colony lifts	•				

Buffers for Horizontal DNA Electrophoresis



Two buffers commonly used for DNA agarose electrophoresis are Tris-acetate with EDTA (TAE; 40mM Tris-acetate, 1mM EDTA) and Tris-borate with EDTA (TBE, 89mM Tris-borate, 2mM EDTA). Because the pH of these buffers is neutral, the phosphate backbone of DNA has a net negative charge and migrates toward the anode. TAE and TBE have different properties which makes one more suitable than the other for specific purposes.

TAE: DNase, RNase and Protease free		
Cat. No	Concentration	Quantity
10542785	1X	4L
10123293	1X	20L
10628403	10X	500mL
10041223	10X	1L
10775494	10X	4L
10775494	10X	20L
10490074	25X	1L
10457583	50X	500mL
10490264	50X	1L
10542985	50X	4L
10326463	50X	20L
10255303	25X	1L**

TBE: DNase and RNase free		
Cat. No	Concentration	Quantity
10754914	1X	1L
10715684	1X	4L
10755104	1X	20L
11898562	5X	1L*
10727224	10X	1L
10031223	10X	4L
10563155	10X	20L
10448543	10X	1L**

*Pre-weighed powder in poly bottle. Dissolve in water
**Pre-weighed powder in foil pack. Dissolve in water

Buffer Components for Horizontal DNA Electrophoresis



A range of high purity individual reagents for buffer formulation.

Cat. No	Quantity
Tris base	
10103203	500g
10376743	1kg
10724344	5kg
10667243	10kg
10336793	25kg
Acetic acid glacial	
10021123[†]	500mL
Boric acid	
10522595[†]	500g
10011083[†]	1kg
EDTA disodium salt	
10618973[†]	500g
10522965[†]	1kg

*Polymerase Chain Reaction (PCR) is a process covered by patents owned by Hoffmann-La Roche

[†] Refer to page 67, GHS hazard information.



Fisher BioReagents®

Buffers for Horizontal RNA Electrophoresis

MOPS is a commonly used buffer system for RNA electrophoresis using formaldehyde or formamide denatured RNA. It is important to use RNase free chemicals, water, and containers when preparing the buffer solution. The typical formulation of a 10X MOPS running buffer is 0.4M MOPS (pH 7.0), 0.1M sodium acetate, and 0.01M EDTA.

Cat. No	Description	Quantity
10234673†	MOPS biological buffer DNase RNase and protease free	100g
10234723†	MOPS biological buffer DNase RNase and protease free	500g
10295243	Water DNase RNase and protease free	50mL
10336503	Water DNase RNase and protease free	100mL
11448023	Water DNA grade, DNase and protease free	1L
10245203	Water, RNA grade, sterile, DNase RNase and protease free, DEPC treated	1L



Fisher BioReagents®

Sample Loading Dyes

Sample loading dyes are added to DNA and RNA samples prior to electrophoresis on agarose gels.

Cat. No	Description	Quantity
10205023	Agarose gel loading dye 6X	5mL
10205263	Glycerol gel-loading dye 5x DNase and RNase free	1mL
10400084	Glycerol gel-loading dye 5x DNase and RNase free	5mL
10679733	Bromophenol blue	25g
10532965†	Xylene cyanol FF	10g



Fisher BioReagents®

DNA Visualisation

Used for fluorometric detection of double stranded nucleic acids.

Cat. No	Description	Quantity
10132863†	Ethidium bromide solution 1%	10mL
10726074†	Ethidium bromide	1g
10678973†	Ethidium bromide	5g



Fisher BioReagents®

DNA Ladders

exACTGene™ and routine DNA ladders

Ready to use (pre-mixed with the loading dye), room temperature, stable DNA ladders are available for all common electrophoresis applications.

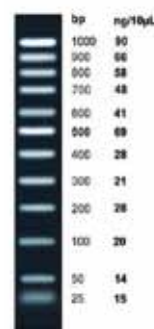

Cat. No 10657633

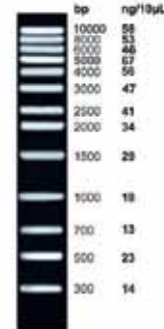

Cat. No 10489883

exACTGene® DNA ladders are ideal for qualitative analysis, quantitative estimation and size assessment

Cat. No	Application	Size Range	Number of Bands	Number of Loadings
10214973	PCR fragment analysis	25 to 650bp	14	100/10µL
10657633	PCR fragment analysis, small DNA digests	25 to 1,000bp	12	100/10µL
10224973	Quick check of PCR or enzyme digestion results	50 to 2,000bp	8	100/10µL
10061413	General purpose, small DNA fragments	100 to 1,000bp	10	100/10µL
10021463	Fast run times, small DNA fragments	100 to 2,000bp	11	100/10µL
10306943	Clone identification	100 to 2,686bp	14	100/10µL
10031463	Large size PCR or cloning	300 to 5,000bp	10	100/10µL
10122823	Small and large cloning application	100 to 5,000bp	16	100/10µL
10489883	General purpose, large digested DNA	300 to 10,000bp	13	100/10µL
10499883	General purpose, wide separation range	100 to 10,000bp	19	100/10µL
10699163	General purpose, extra large DNA fragments	300 to 24,000bp	15	100/10µL

Routine DNA ladders are designed for qualitative analysis and size assessment

Cat. No	Application	Size Range	Number of Bands	Number of Loadings
10284633	Small fragments, quick size assessment	50-2000bp	11	200/5µL
10450464	Quick size assessment of broad size range	50-10,000bp	16	200/5µL



Fisher BioReagents®

Other Bioreagents

Cat. No	Description	Quantity
10021123†	Acetic acid glacial	500mL
10021083	Glycerol, DNase, RNase and protease free	1L
10468343	Ficoll 400 m.w. 400,000, DNase, RNase and protease free molecular biology grade	100g

† Refer to page 67, GHS hazard information.

PRODUCING YOUR OWN STOCK SOLUTIONS FOR HORIZONTAL GEL ELECTROPHORESIS



50X TAE (Stock Solution)

Fisher BioReagents  Fisher BioReagents®

- Tris base (Cat. No 10376743)
- Glacial acetic acid (Cat. No 10021123)[†]
- 0.5M EDTA (Cat. No 10618973)[†]

Equipment and consumables **Fisherbrand**



Beakers
page 55



Bottles
page 55



Stirrers
page 59



Magnetic followers
page 59



Measuring cylinders
page 55



pH meters
page 61

Method

Weigh out 242g Tris base (FW = 121) and dissolve in 750mL distilled water.
Add 57.1mL glacial acetic acid and 100mL 0.5M EDTA (pH 8.0).
Make up to 1L with distilled water.

Stock solution can be stored at room temperature. The pH of the buffer is not adjusted and should be in the range of 8.2 to 8.5.

1X TAE (Working Solution)

Method

Dilute stock solution by 50X in distilled water. Final concentrations are:

- 40mM Tris pH 7.6
- 20mM glacial acetic acid
- 1mM EDTA

50X TBE (Stock Solution)

Fisher BioReagents  Fisher BioReagents®

- Tris base (Cat. No 10376743)
- Boric acid (Cat. No 10011083)[†]
- 0.5M EDTA (Cat. No 10618973)[†]

Equipment and consumables **Fisherbrand**



Bottles
page 55



Stirrers
page 59



Magnetic followers
page 59



Measuring cylinders
page 55



pH meters
page 61

Method

Weigh out 108g Tris base (FW = 121) and dissolve in 750mL distilled water.
Add 55g boric acid (FW = 61.8) and 40mL 0.5M EDTA (pH 8.0).
Make up to 1L with distilled water.

Stock solution can be stored at room temperature.

1X TBE (Working Solution)

Method

Dilute stock solution by 10X in distilled water. Final concentrations are:

- 89mM Tris pH 7.6
- 89mM boric acid
- 2mM EDTA

[†] Refer to page 67, GHS hazard information.

6X DNA Loading Buffer

Fisher Bioreagents  Fisher BioReagents®

- Glycerol (Cat. No 10021083)
- 1M Tris-HCl pH 8.0 (refer to recipe for 1M Tris-HCl page 39)
- 0.5M EDTA (Cat. No 10618973)†
- Bromophenol blue (Cat. No 10679733)
- Xylene cyanol FF (Cat. No 10532965)†
- Water (Cat. No 10336503)

Equipment and consumables **Fisherbrand®**



Beakers
page 55



Bottles
page 55



Stirrers
page 59



Magnetic followers
page 59



Measuring cylinders
page 55

Method

Pipette 60mL glycerol into a glass beaker.

Add 6mL 1M Tris-HCl pH 8.0 and 1.2mL 0.5M EDTA pH 8.0.

Add 32.8mL water and mix well.

To the solution add either 60mg of bromophenol blue or 60mg xylene cyanole FF.

In a 1% agarose gel the tracking dyes are expected to run at approximately 300bp for bromophenol blue and 40,000bp for xylene cyanole.

Ethidium Bromide Solution

Fisher Bioreagents  Fisher BioReagents®

- Ethidium bromide (Cat. No 10678973)†
- Water (Cat. No 10336503)

Equipment and consumables **Fisherbrand®**



Safety gloves
page 65



50mL tubes
page 53



Vortex mixers
page 61



Amber bottles
page 63

Method

Weigh 0.5g ethidium bromide.

Dissolve in 50mL of water.

Mix to ensure all powder has entirely dissolved.

Transfer to an amber bottle, and store at 4°C.



CAUTION!

Ethidium bromide is a known mutagen. Always wear gloves when handling and wear a respiratory mask when weighing the powder. Wear UV safety goggles to protect skin and eyes when using any UV light source.

† Refer to page 67, GHS hazard information.



TECHNICAL RESOURCES

Here to give you a helping hand!

Fisher Scientific's Product Support Team is your dedicated resource. Our Product Support Advisors are all highly qualified professionals who are here to support and guide you to the fastest, most effective and efficient answer to your enquiry.

Areas of technical expertise include:

- Bioreagents and Life Science
- Chemicals and Chromatography
- Consumables
- Equipment
- Safety

This section features a helpful troubleshooting guide and FAQ's. If, however, this information does not resolve the issue, or if you have questions not covered below

Contact our Product Support Advisors
Tel: 01509 555888
Email: fisheruk.productsupport@thermofisher.com

Horizontal Gel Unit Troubleshooting Guide

The following table lists some of the most commonly experienced problems with horizontal gel units along with useful suggestions for solving them.



Problem	Suggestions
No bubbles appear at the electrodes when operating voltage is applied	<ul style="list-style-type: none"> • Ensure that the d.c. power supply is properly connected
Melted agarose leaks when casting	<ul style="list-style-type: none"> • When using casting gates, ensure that the sealing surfaces of the running tray and the gel casting gates are clean • Ensure that the ends of the running tray are flat and free of nicks
Sample well deformed	<ul style="list-style-type: none"> • Allow the gel to set for a minimum of 30 minutes • Leave comb in position until gel returns to room temperature before removing • Remove the comb both slowly and at a slight angle to prevent gel from breaking • Avoid damaging the well with the pipettor when loading the sample; aim for the centre of the well and avoid damaging the bottom of the well with the pipettor tip
Samples leak underneath the gel upon loading	<ul style="list-style-type: none"> • The bottom of the wells were torn when the comb was removed. To avoid tearing, carefully wiggle the comb to free the teeth from the gel



Problem



Suggestions

<p>Samples do not run straight</p>	<ul style="list-style-type: none"> • Comb may be warped - should be replaced • Running tray may be warped - should be replaced • Reduce the voltage to reduce heat build-up within gel • Choose a buffer with suitable ionic strength and buffering capacity
<p>'Smiling' along one edge of the gel</p>	<ul style="list-style-type: none"> • Gel was not level when cast or run - use a gel levelling table to ensure that the apparatus is level before gel casting and electrophoresis
<p>Bromophenol Blue dye turns yellow</p>	<ul style="list-style-type: none"> • Check pH of buffer during electrophoresis (pH change) • Ensure Tris base and not Tris-HCl was used • Mix the buffer periodically during electrophoresis • Connect a pump to circulate the buffer
<p>Double-banded pattern</p>	<ul style="list-style-type: none"> • Ensure the comb is vertical during casting so that the well shape is not distorted • Decrease the buffer level to 1mm above the top of the gel. This will reduce the temperature gradient through the gel • Increase concentration of the sample and use a thin (2mm to 3mm) gel with a thin (1mm) comb
<p>'Tailed' bands (excessive fluorescence appearing above the band)</p>	<ul style="list-style-type: none"> • Reduce amount of nucleic acid in the sample
<p>Poor band resolution</p>	<ul style="list-style-type: none"> • Add Ficoll (Cat. No 10468343*), glycerol (Cat. No 10021083*), or sucrose to the sample loading buffer to ensure that the sample forms a compact layer at the bottom of the well. Ensure sample is completely dissolved • Reduce voltage, sample concentration, or sample volume • Ensure there is at least 1mm of gel below the bottom of the comb to prevent samples from leaking out the bottom of the well • Reduce salt concentration of the sample. High salt concentrations can cause 'pinched' lanes, smeared lanes, arched dye front and slow migration • Check enzyme activity; may require longer digestion or different restriction buffer • Prepare fresh sample if nuclease contamination is suspected • Choose agarose with low endosmosis value
<p>Gel melts or softens near sample wells</p>	<ul style="list-style-type: none"> • Caused by a combination of pH drift and high temperature. Circulate or remix buffer periodically or reduce the voltage

* refer to page 17 for further details on these Fisher Bioreagents

Frequently asked questions (FAQ's) – Horizontal Gel Electrophoresis

This section lists the most frequently asked questions received by our Life Science and Chemical Specialists, together with the answers they provided (also refer to pages 43 to 45 and 51). If you are unable to find the answer to your question, are stuck and need help or are simply confused and unsure of which product best suits your research needs, the Product Support Team are here and ready to respond to your enquiries.



Have a question?



Confused?



Stuck, need help??

Contact our Product Support Advisors

Tel: 01509 555888

Email: fisheruk.productsupport@thermofisher.com

Q. Which buffer should I use for my agarose gel electrophoresis?

A. The type of buffer used to run DNA in agarose gel electrophoresis depends primarily on the size of DNA fragment and the post-electrophoresis application. Two buffers commonly used for DNA agarose electrophoresis are Tris-Acetate with EDTA (TAE; 40mM Tris-Acetate, 1mM EDTA) and Tris-Borate with EDTA (TBE, 89mM Tris-Borate, 2mM EDTA). Because the pH of these buffers is neutral, the phosphate backbone of DNA has a net negative charge and migrates toward the anode.

TAE and TBE have different properties which makes one more suitable than the other for specific purposes. For larger DNA fragments (>10kb) TAE is preferred. For smaller DNA fragments (<1kb) TBE is generally preferred as it has a greater buffering capacity and will give sharper resolution than TAE. TAE is also the preferred choice of buffer when the DNA sample is to be used in cloning experiments as the borate in the TBE buffer is a strong inhibitor for many enzymes.

Q. How thick should I cast my agarose gel?

A. The recommended thickness for agarose gel is 3 to 4 mm. Gels thicker than 5mm will result in fuzzy bands.

Q. I wish to run a gel to separate DNA fragments from 100 to 2,000bp. Which agarose do you suggest?

A. Fisher Bioreagents Cat. No 10766834 agarose, molecular biology grade, is well suited for routine separation of DNA and RNA in the range 500bp to 23kb. For separation of fragments in the 100 to 2,000bp range, we would suggest Fisher Bioreagents Cat. No 10766834, increasing the gel concentration (>2%) and using TBE buffer (not TAE).

Q. Which is the best agarose for comet electrophoresis?

A. The comet assay (single cell gel electrophoresis) is a simple method used for measuring DNA strand breaks in eukaryotic cells. A low melting point agarose is usually required. We would suggest Fisher Bioreagents Cat. No 10377033 as this is a low melting, molecular biology grade agarose which is ideal for separating and recovering nucleic acids.

Q. How much DNA do I need to load on to a gel?

A. You should load no more than 100ng of DNA. This amount should give you a clear well-defined band when stained with ethidium bromide and viewed under a UV light. If you load too much DNA then you will see a smear.

Q. Is the dye proprietary in Cat. No 10205023?

A. The loading dyes in Fisher Bioreagents Cat. No 10205023, agarose gel-loading dye, 6X are a unique blend of three tracking dyes that make estimating sample migration simple and reliable:

- Dye #1 – a light blue dye that migrates at about 4,000 base pairs in 1% agarose
- Dye #2 – an indigo dye that migrates at about 600 base pairs in 1% agarose
- Dye #3 – a magenta dye that migrates at about 10 base pairs in 1% agarose

Q. At what voltage should I run my agarose gel?

A. The recommended voltage is 4 to 10 volts/cm (cm is determined by measuring the interelectrode distance, i.e the distance between anode and cathode, not the length of the gel) under normal electrophoretic conditions. If the voltage is too low, the mobility of small DNA (<1,000bp) is reduced and band broadening will occur due to diffusion. If the voltage is too high, the band resolution is reduced, mainly because of gel overheating.

Q. Should I recirculate the buffer during electrophoresis?

A. Recirculation prevents the formation of pH gradient and buffer depletion, so it is advisable to recirculate the buffer especially during extended electrophoresis. Buffer recirculation is also important when running larger TAE gels due to the lower buffering capacity of TAE.

Q. How should I dispose of ethidium bromide gel stain?

A. Ethidium bromide destaining bags are available, Fisher Bioreagents Cat. No 12861680. These bags will remove up to 5mg ethidium bromide when stirred with solution overnight. However, as disposal regulations vary, please contact your local safety officer for disposal guidelines.

Q. Do you have any information regarding the amount of DNA plasmid for each band for Cat. No 10284633?

A. We do not have information regarding the amount of DNA in each discrete fragment (band) of Fisher Bioreagent Cat. No 10284633, low scale (100bp) DNA ladder. This DNA ladder is meant to be a general purpose sizing standard for DNA fragments such as PCR* amplicons separated on agarose mini gel. It is not meant to be used as a quantitative standard. However, for quantitation, we have the exACTGene DNA ladders such as Fisher Bioreagents Cat. No 10021463; this low range plus DNA ladder provides the approximate amount of DNA in each band.

References

1. Maniatis, T., Fritsch, E. F. and Sambrook, J. (1982) *Molecular Cloning: A Laboratory Manual*, Cold Spring Harbor Laboratory, Cold Spring Harbor, New York
2. Rickwood, D. and Hames, B. D. (eds.) (1982) *Gel Electrophoresis of Nucleic Acids: A Practical Approach*, IRL Press, Oxford, England
3. Longo, M. C. and Hartley, J. L. (1986) *Focus* 8:3, 3
4. Ausubel, et al., (eds). (1993) *Current Protocols in Molecular Biology*. Greene Publishing and Wiley-Interscience, New York

*Polymerase Chain Reaction (PCR) is a process covered by patents owned by Hoffmann-La Roche

DISCLAIMER: Please note that whilst Fisher Scientific makes every effort to ensure that information provided to customers is accurate, all information or suggestions offered by Fisher Scientific are based upon the information provided by customers and is intended to be general in nature only. Fisher Scientific cannot guarantee that any information or suggestions are suitable for the particular needs or requirements of customers, and customers are encouraged to conduct their own assessment of any information or suggestions given.

FOCUS ON PROTEOMICS WORKFLOW

Depend on Fisherbrand, Fisher Chemical and Fisher Bioreagents to provide products for every step of your Proteomics workflow.



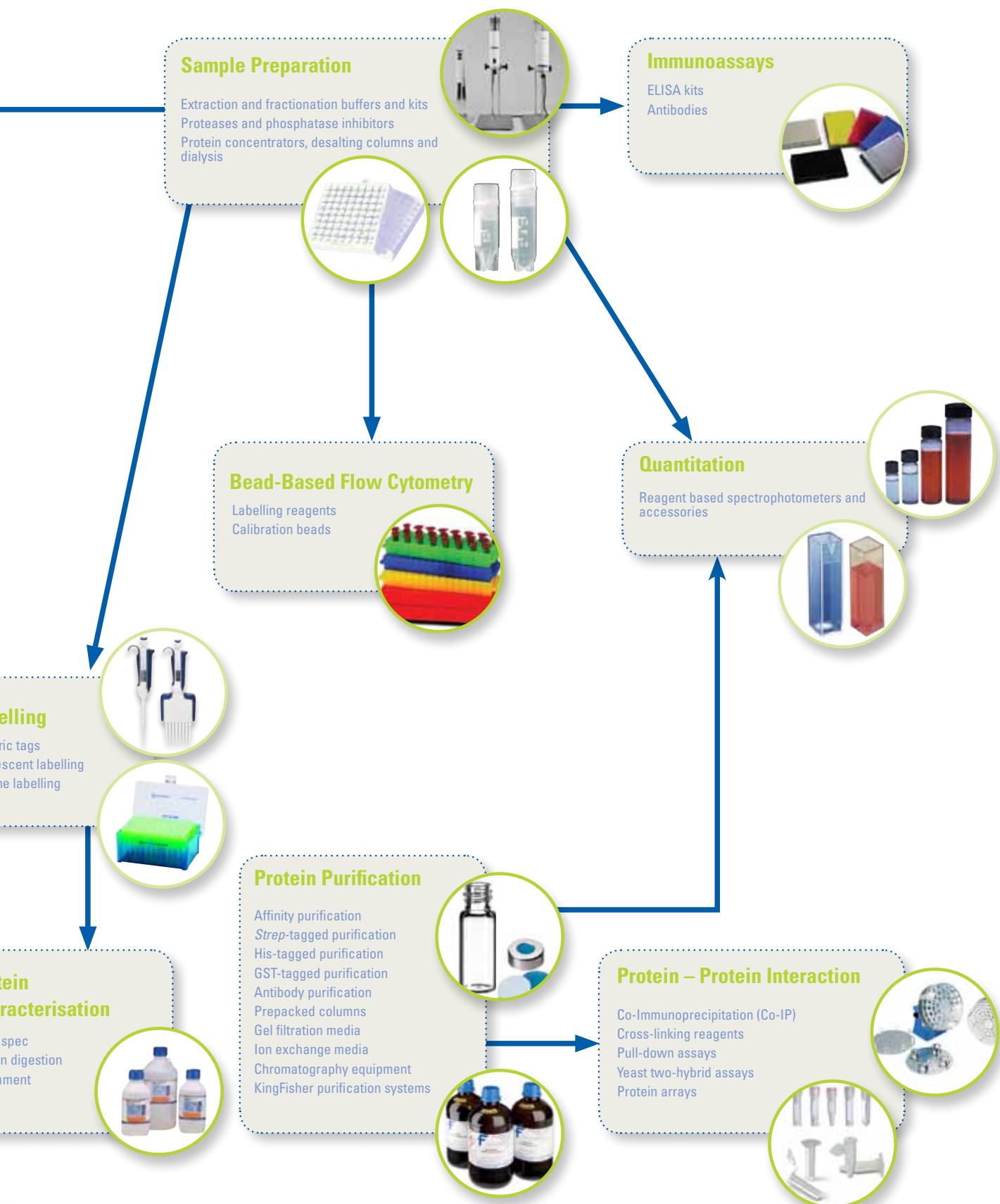



**nl
su**

**new lab
start-up** programme
2013/2014

A sure start to laboratory excellence

NEW Fisher Scientific Laboratory Catalogue is out Now!



What's NEW?

- Major new additions for liquid handling, freezers, ovens and small bench top equipment
- Extended Fisherbrand range
- New improved layout, making it easier than ever to find your products
- At-a-glance extended warranty options
- QR codes for your smartphone
- Brand new electrochemistry chapter
- New look Chromatography section

Request your copy



INTRODUCTION TO VERTICAL GEL ELECTROPHORESIS

Sodium Dodecyl Sulfate-polyacrylamide gel electrophoresis (SDS-PAGE) is the most direct method for assessing, in a fast and reproducible manner, the relative molecular weight (M_r) of denatured proteins and polypeptide chains and the purity of a protein preparation. In SDS-PAGE, the sample to be applied to the gel is first treated with the anionic detergent SDS which denatures the proteins in the sample and binds tightly to the protein molecules. The SDS molecules confer a relatively uniform negative charge to the polypeptide in proportion to its length. When an electric current passes through the gel, all proteins will migrate through the gel matrix toward the anode. In this way, SDS-PAGE separates proteins according to size because the SDS-coated proteins have a uniform charge:mass ratio; proteins with less mass travel more quickly through the gel than those with larger mass because of the sieving effect of the gel matrix.

This section provides an overview of the range of Fisherbrand vertical gel units. The units comprise a modular tank design with dedicated inserts for Polyacrylamide Gel Electrophoresis (PAGE), blotting and capillary gel Isoelectric Focusing (IEF). It also features Fisherbrand semi dry blotters and gel dryers as well as essential Fisher Bioreagents, such as acrylamides, protein standards, buffers and DNA visualisation agents.

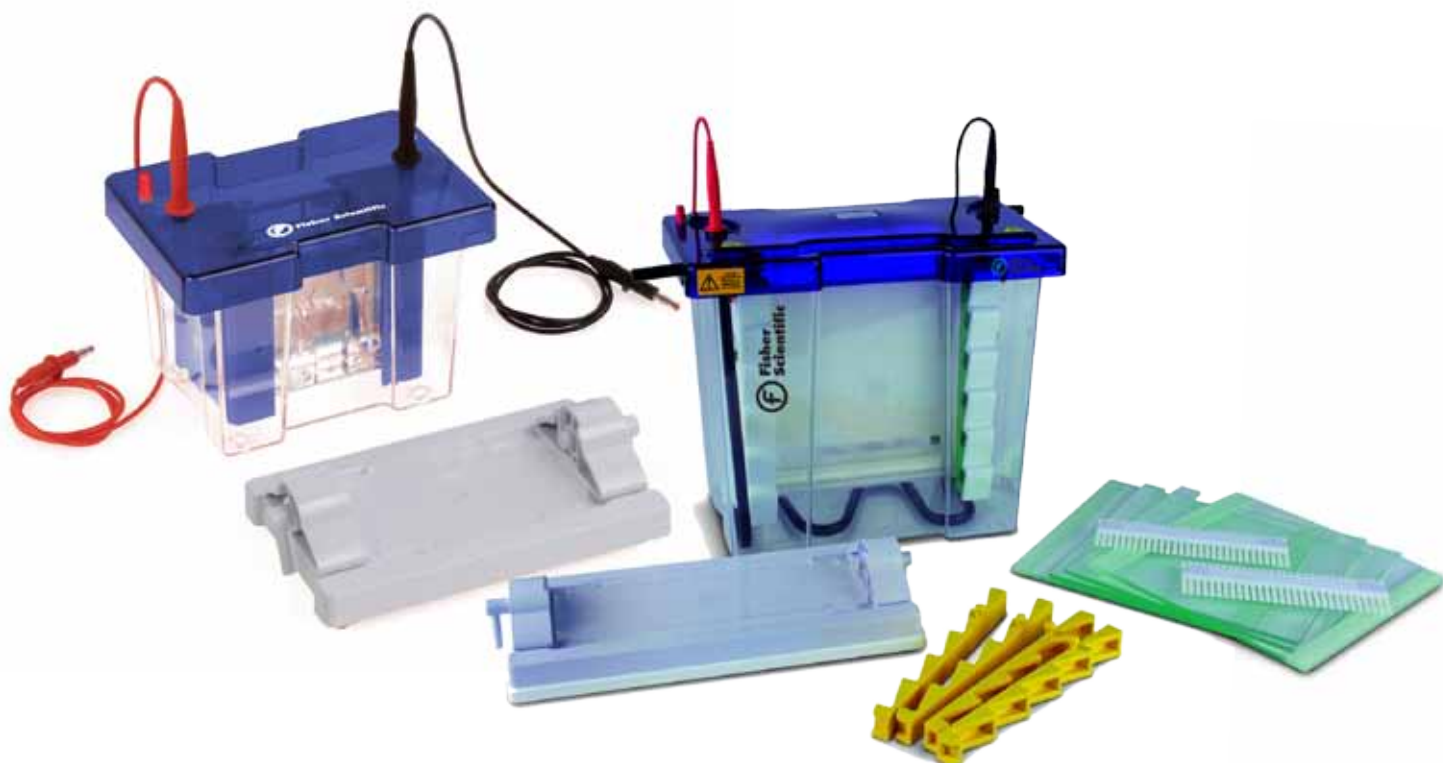

VERTICAL GEL UNITS

The Fisherbrand range of vertical gel systems include both the Mini (for 100mm x 100mm gels) and Maxi units (for 200mm x 200mm gels). Each vertical gel unit is supplied with combs, glass plates and accessories to run up to either four Mini gels or two Maxi gels. The same tank can be used for both gel casting and gel running, eliminating time consuming transfer of fragile gels between separate casting and running modules.

To view the instruction manuals for the following range of vertical gel units visit www.eu.fishersci.com/fisherbrand.

The Verti-Gel Mini system

The Fisherbrand Verti-Gel Mini units are available in two different formats, the two gel system which can accommodate up to two handcast or commercial precast gels (also referred to as the Standard System), or the four gel system which is equipped with enough glass plates and combs to run four gels (also referred to as the Tetrad System). This flexibility of formats, together with the unique sliding clamp technology within the PAGE insert, permits fast, intuitive leak free casting.

Verti-Gel Mini component parts

- 1 Lid and power cables
- 2 PAGE insert
- 3 Sliding clamps
- 4 Glass plates
- 5 Inner buffer chamber
- 6 Gasket
- 7 Outer tank
- 8 Cam-pin caster
- 9 Ultra soft casting mat
- 10 Combs

Technical Specification

Number of gels.....	1 to 4
Precast gel compatibility (Up to two gels/run)	IDGel™, Novex™, SERVAGel™, Thermo Precise Pierce Protein Gel
Handcast gels (Up to four gels/run).....	Using 100mm x 100mm glass plates
Plate dimensions (w x h x t), mm	100 x 100 x 20
Gel dimensions (w x h), mm.....	80 x 85
Total buffer volume for two gels, mL.....	Min: 250; Max: 1,200
Total buffer volume for four gels, mL.....	Min: 250; Max: 1,200
Standard run time for SDS-PAGE.....	1 to 2 hours
Recommended power supplies.....	12613546 (page 47)
Unit dimensions (w x d x h), mm.....	190 x 130 x 150
Mass, kg.....	1.8

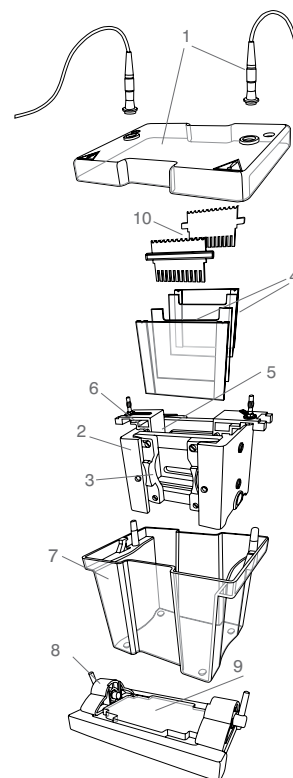

Use Verti-Gel Mini vertical systems to:

- Run a maximum of four gels within an hour
- Perform 2D and blotting within a day
- Undertake discovery projects
- Screen new samples and evaluate sample preparation conditions

Loading and running innovations

- Reversible combs also serving as loading indicators aid pipettor-well alignment, preventing sample loading errors – simply insert your comb into a freshly poured gel which is allowed to set before inverting the comb to use a loading template that sits conveniently above the newly formed sample wells
- Run up to four gels in a single PAGE module using a combination of plain and notched glass plates with spacers in between corresponding to your chosen gel thickness

Dedicated modules for different applications

- Interchangeable modular inserts for slab gels, 2D electrophoresis and electroblotting allow the user to switch quickly and easily from one electrophoresis technique to another, using the same, single universal buffer tank and lid. Our modular system configurations are as follows:
 - Cat. No 15136624, 15116624 and 15146624 – supplied with casting base and external casting module for running up to four handcast or two precast native PAGE and SDS-PAGE gels (refer to page 30 to 31)
 - Cat. No 15156624, 15126624 and 15176624 – also includes blotting insert to transfer up to four gels for Western blotting (refer to pages 30 to 31); tube gel 2D insert available separately (refer to page 31)
 - Cat. No 11893293 – supplied only with tank, lid and PAGE insert for running 100mm x 100mm and 100mm x 80mm (w x h) precast gels (refer to page 30)
 - Cat. No 11843293 – complete with combs, bonded spacer and notched glass plates, to run up to two tapecast gels or two handcast gels using caster (refer to page 30)
 - Cat. No 11883293 – complete blotting system with PAGE and blotting inserts; glass plates make two gels (refer to page 30)



11843293



11883293

Optional blotting insert

The Verti-Gel Mini blotting insert uses the same tank and lid to adapt your Verti-Gel Standard or Tetrad system for fast, high quality electroblotting of mini gels. Able to transfer four gels at a time, the Verti-Gel Mini blotting insert is available in the traditional wire electrode format. This insert is available as a stand-alone add-on (Cat. No 11837623) to the Verti-Gel Mini system or as part of a fully integrated system for multiple electrophoresis techniques (Cat. No 11883293).

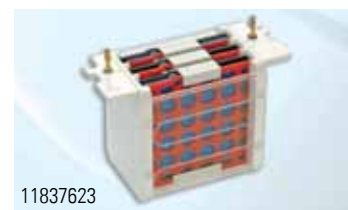

11837623

Optional 2D Insert

The Verti-Gel Mini capillary tube gel insert may be used with the same tank and lid to adapt your Verti-Gel Mini Standard or Tetrad system for reproducible 2D electrophoresis. IEF of up to 10 capillary tube gels may be achieved in as little as 3.5 hours, while second dimension PAGE takes no more than an hour. Available as a standalone add-on (11867623).



11867623

Cast and run with Verti-Gel mini sliding clamp technology

- The unique sliding clamp technology of the Verti-Gel Mini insert ensures simple, rapid, leak proof gel casting in four easy steps (see below).
- Flat, ultra soft moulded gasket acts in tandem with a unique single piece pressure-clamping frame to facilitate even pressure distribution to minimise gel compression; gasket reversible for Bio-Rad compatibility.
- Spacers are colour coded with compatible comb thickness and are bonded to 2mm thick ground glass plates to guarantee correct alignment and leak free casting, whereas notched glass plates with bonded spacer option, included with the four gel system, doubles gel capacity of the PAGE insert; optional dummy plate allows for single gels to be run.



1

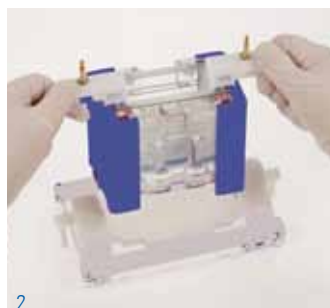

2



3



4

Insert glass plates into PAGE insert and slide clamps into side cheeks to create an effective seal to prevent current leakage during electrophoresis.

Benefit: PAGE insert is used for both gel casting and running which unlike other leading brands, eliminates time-consuming transfer of potentially fragile glass plates between separate casting and running modules.

Transfer PAGE insert to casting base, insert cams and turn until tightened.

Benefit: Ultra soft gasket within casting base compensates for plate misalignment to prevent leakage.

Pour in gel solution, insert comb and allow to polymerise.

Transfer PAGE insert to tank, fill with buffer, load samples, replace lid and run.

Vertical Gel Electrophoresis

Verti-Gel Mini, 2-Gel System (Standard)

For Mini SDS PAGE, native PAGE, gradient, second dimension and nucleic acid separations.

- Injection moulded construction, durable and leak proof
- Compatible with all 80mm x 100mm and 100mm x 100mm precast gels
- Low buffer volumes
- Run up to two gels
- Interchangeable modules for IEF/2D electrophoresis and electroblotting in a universal tank

Technical Specification

Dimensions [l x w], mm	100 x 100 (plate), 75 x 80 (gel)
Dimensions [l x w x h], mm	190 x 130 x 150 (unit)
Capacity	40 samples, 20 samples per gel
Volume, mL	250 to 1,200 (buffer)
No. of samples	1, 5, 8MC, 9, 10, 12, 16MC, 20 (per comb)
Thickness, mm	0.5, 0.75, 1, 1.5, 2 (combs)

MC = Multichannel pipettor compatible

Cat. No	Description
11843293	Verti-Gel Mini 100mm x 100mm including caster (for handcast gels)
11893293	Verti-Gel Mini 100mm x 100mm, no caster (for pre-cast gels)
11883293	Complete system for Verti-Gel Mini vertical (100mm x 100mm) electrophoresis and blotting



Verti-Gel Mini, 4-Gel System (Tetrad)

- Injection moulded construction, durable and leak proof
- Compatible with all 80mm x 100mm and 100mm x 100mm precast gels
- Low buffer volumes
- Run up to four gels
- Interchangeable modules for IEF/2D electrophoresis and electroblotting in a universal tank

Technical Specification

Dimensions [l x w], mm	100 x 100 (plate), 75 x 80 (gel)
Dimensions [l x w x h], mm	190 x 130 x 150 (unit)
Capacity	80 samples, 20 samples per gel
Volume, mL	250 to 1,200 (buffer)
No. of samples	1, 5, 8MC, 9, 10, 12, 16MC, 20 (per comb)
Thickness, mm	0.5, 0.75, 1, 1.5, 2 (combs)

MC = Multichannel pipettor compatible

Cat. No	Description
15136624	Verti-Gel Mini Tetrad PAGE system with sliding clamps 100mm x 100mm, caster & external stand, 4x notched/plain plates with 0.75mm bonded spacers, 4x notched plates, 4x 12 well 0.75mm combs
15116624	Verti-Gel Mini Tetrad PAGE system with sliding clamps 100mm x 100mm, caster & external stand, 4x notched/plain plates with 1mm bonded spacers, 4x notched plates, 4x 12 well 1mm combs
15146624	Verti-Gel Mini Tetrad PAGE system with sliding clamps 100mm x 100mm, caster & external stand, 4x notched/plain plates with 1.5mm bonded spacers, 4x notched plates, 4x 12 well 1.5mm combs
15156624	Verti-Gel Mini Tetrad PAGE system with blotting module 100 x 100mm, caster & external stand, 4x notched/plain plates with 0.75mm spacer, 4x plate, 4x 12 well 0.75mm comb, 4x cassette, 8x pad
15126624	Verti-Gel Mini Tetrad PAGE system with blotting module 100 x 100mm, caster & external stand, 4x notched/plain plates with 1mm spacer, 4x plate, 4x 12 well 1mm comb, 4x cassette, 8x pad
15176624	Verti-Gel Mini Tetrad PAGE system with blotting module 100 x 100mm, caster & external stand, 4x notched/plain plates with 1.5mm spacer, 4x plate, 4x 12 well 1.5mm comb, 4x cassette, 8x pad



Combs and Accessories

Combs	Thickness 0.50mm		Thickness 0.75mm		Thickness 1.0mm		Thickness 1.5mm		Thickness 2.0mm	
	Cat. No	Sample size, µL	Cat. No	Sample size, µL	Cat. No	Sample size, µL	Cat. No	Sample size, µL	Cat. No	Sample size, µL
1 prep, 1 marker	11837583	330	11847583	500	11807593	650	11817593	1,000	11827593	1,300
5 sample,	11887603	45	11897603	70	11807613	100	11817613	140	11827613	200
8 sample MC	11837613	25	11847613	40	11857613	60	11867613	80	11877613	120
9 sample	11887613	23	11897613	35	11807623	50	11817623	70	11827623	100
10 sample	11857583	20	11867583	30	11877583	40	11887583	30	11897583	80
12 sample	11837593	16	11847593	25	11857593	35	11867593	50	11877593	70
16 sample MC	11887593	13	11897593	20	11807603	25	11817603	40	11827603	50
20 sample	11837603	10	11847603	15	11857603	20	11867603	30	11877603	40



Cat. No	Description	Pack qty
Accessories - General		
11847623	100mm x 100mm casting base	1
11857623	Replacement silicone mat for 100mm x 100mm casting base	1
11853293	Inner running module sliding clamps	1
11887623	Mini cooling pack	1
11887633	Notched glass plates 100mm x 100mm	2
11847643	Plain glass plates 100mm x 100mm	2
11857643	Plain glass plates 100mm x 100mm with 0.5mm bonded spacers	2
11897633	Notched glass plates 100mm x 100mm with 0.5mm bonded spacers	2
11807643	100mm x 100mm notched glass plates with 0.75mm bonded spacers	2
11867643	100mm x 100mm plain glass plates with 0.75mm bonded spacers	2
11817643	100mm x 100mm notched glass plates with 1mm bonded spacers	2
11877643	100mm x 100mm plain glass plates with 1mm bonded spacers	2
11827643	100mm x 100mm notched glass plates with 1.5mm bonded spacers	2
11887643	100mm x 100mm plain glass plates with 1.5mm bonded spacers	2
11837643	100mm x 100mm notched glass plates with 2mm bonded spacers	2
11897643	100mm x 100mm plain glass plates with 2mm bonded spacers	2
11877623	Dummy plate 100mm x 100mm	1
11807653	Spacers 10mm x 100mm 0.5mm thick	2
11817653	Spacers 10mm x 100mm 0.75mm thick	2
11827653	Spacers 10mm x 100mm 1mm thick	2
11837653	Spacers 10mm x 100mm 1.5mm thick	2
11847653	Spacers 10mm x 100mm 2mm thick	2
11817583	Replacement platinum wire - 500mm x 0.2mm	1
11863293	Caster stand	1
Accessories - Blotting		
11837623	Mini blotting module	1
11827583	Verti-Gel blot mini cassette	1
11857653	Fibre pad for blotting 100mm x 100mm gels	1
Accessories - 2D Electrophoresis		
11867623	Mini IEF module	1
11877653	Capillary tube 75mm long, 1mm I.D.	1
11867653	Blanking ports	1

Vertical Gel Electrophoresis

Vertical Gel Units, Verti-Gel Maxi

The Fisherbrand Verti-Gel Maxi unit has been designed for large format, 200mm x 200mm gels. It is able to perform a variety of separations, including first dimension and second dimension SDS-PAGE, native, preparative, gradient and high resolution electrophoresis, plus capillary tube gel IEF and electroblotting. The Fisherbrand Verti-Gel Maxi is one of the most versatile maxi systems available.

Featuring the new innovative screw-clamp technology within the PAGE insert, only four screws are now needed to secure the 200mm x 200mm glass plates. This gives the Verti-Gel Maxi a selective advantage of a much faster set up speed. In addition, this new clamping technology ensures that pressure is distributed evenly along the height of the gel rather than in the centre, eliminating plate bowing and gel compression. The Fisherbrand Verti-Gel maintains a leak-proof seal during casting and the ergonomic design of the PAGE insert aids both handling and set up making it easy and quick to use.

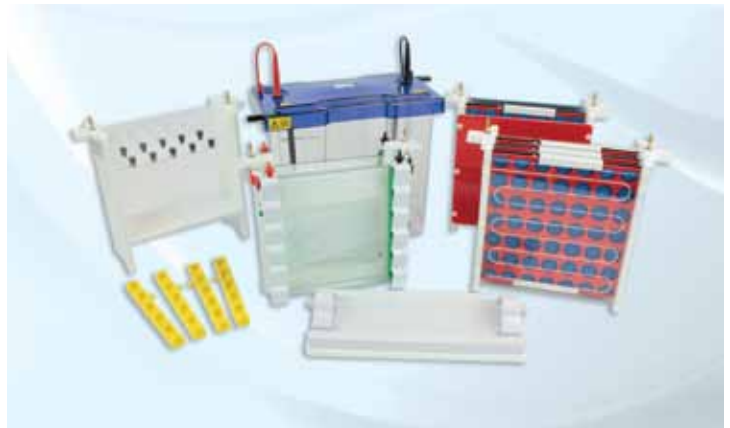

Versatility and Adaptability

- **More gels:** run two gels simultaneously on the standard two Gel Verti-Maxi System
- **Customise your system:** for second-dimension runs with 180mm IPG strips and gels using the IEF conversion kit (Cat. No 15116634)
- **Utilise modular inserts:** with the same universal tank and lid to extend the application of your standard Vert-Gel Maxi unit to create a complete 2D or blotting system:
 - Cat. No 15186634 with capillary tube gel insert for 2D electrophoresis
 - Cat. No 15106644 for two gel electroblotting

Other Benefits

- Bonded spacers and combs colour coded for thickness
- Widest selection of combs allow separation of up to 192 samples
- Robust 4mm thick glass plates
- Asymmetric lid design and colour coded screw-pins in PAGE insert prevent polarity reversal
- All parts injection moulded using durable industrial grade plastic to guarantee longevity and reliable and consistent performance

Verti-Gel Maxi component parts

- 1 Lid and power cables
- 2 PAGE insert
- 3 Vertical screw-pin
- 4 Clamping bars
- 5 Glass plates
- 6 Inner buffer chamber
- 7 Gasket
- 8 Detachable cooling coil
- 9 Outer tank
- 10 Cam-pin caster
- 11 Ultra soft casting mat
- 12 Combs

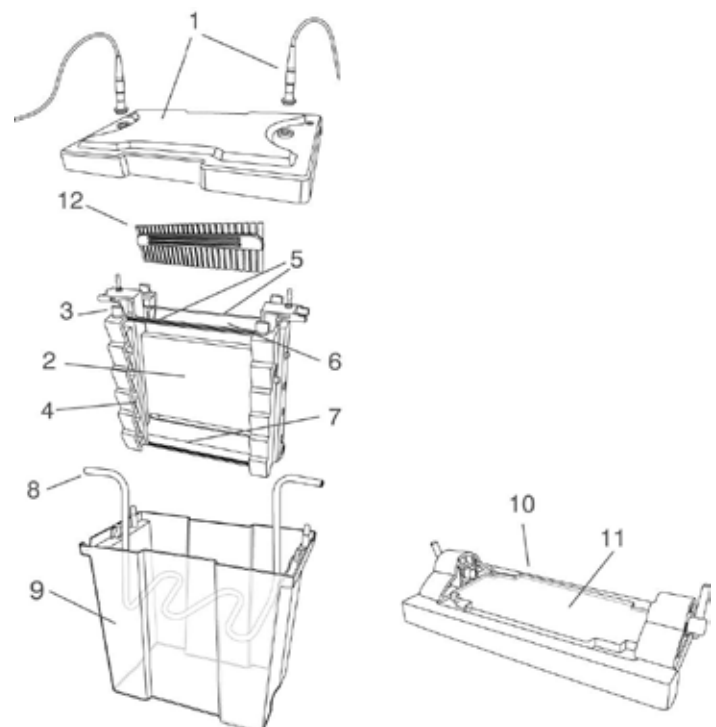

Technical Specification

No. of gels.....	1 to 2
Handcast gels	Using 200mm x 200mm Verti-Gel Maxi glass plates and combs
Plate dimensions (w x h x t), mm	200 x 200 x 4
Standard spacer dimensions (w x h), mm.....	20 x 200
IPG spacer dimensions (w x h), mm	6 x 200
Total volume inner buffer chamber, mL	640
Total buffer volume for two gels, L.....	5.3
Standard run time for SDS-PAGE	
Without cooling, hrs.....	4 to 5
With cooling, hrs.....	3 to 4
Unit dimensions (w x d x h), mm.....	300 x 180 x 270
Mass, kg.....	2.5

Leak Free Casting with Vertical Screw-Pin Technology

1



Assemble each gel cassette on a flat level surface, by placing the plain glass plate down with the spacers facing upwards followed by the notched glass plate.

Benefit: Colour coded spacers consistent with comb thickness are bonded to ground glass plates to ensure correct alignment and leak free casting.

4



Continue to tighten the screw-pins until the gel clamps glide out of the resting slots and fix firmly against the glass plates pushing them upright.

5



Check the bottom of the glass plates to ensure that they are flush together, and place the PAGE insert on the casting base; make sure that the cams are facing downwards.

Benefit: Dual purpose PAGE insert eliminates time consuming transfer of glass plates between separate casting and running modules.

6



Insert cams and turn until tightened, drawing the PAGE insert onto the casting to form a leak proof seal.

Benefit: Ultra soft silicone mat within cam-caster to ensure leak free casting.

7

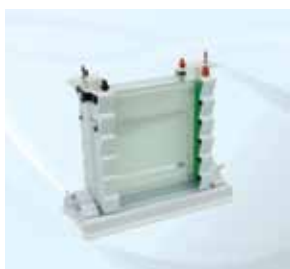

Pour in the gel solution, insert the combs and allow the wells to polymerise.

2



Loosen the vertical screw-pins in the PAGE insert to release the locking mechanism, allowing the gel clamps to sit in the resting slots.

3



Insert a gel cassette into each side of the inner buffer chamber in the PAGE insert, and begin tightening the vertical screw-pins.

Vertical screw-pins, colour coded to prevent polarity reversal, push gel clamps out of the resting slots to secure glass plates firmly within the PAGE insert.

Resting slots allow the gel clamps to sit conveniently out of the way, to aid hinderance free loading of the cassettes into the PAGE insert.

Ergonomic 'wave' design of PAGE insert provides convenient finger grips for easy handling.

Cam-pins lock PAGE insert onto the ultra soft silicone mat within the casting base to provide leak free seal.

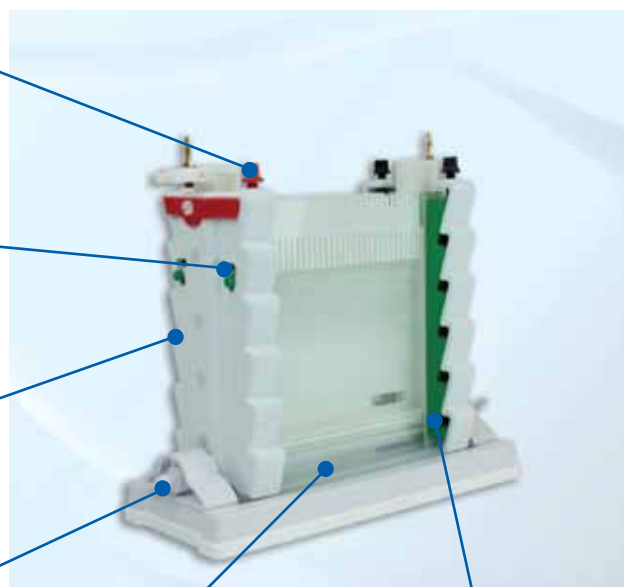

Flat, level gasket prevents current leakage from inner buffer chamber.

Sliding gel clamps available in two thicknesses to accommodate single and double gel cassettes.

8



Transfer the PAGE insert to the gel tank. Fill the inner and outer buffer chambers before loading samples.

9



Replace the lid, connect to the power supply and run.

Vertical Gel Electrophoresis

Verti-Gel Maxi, 2-Gel System (Standard)

- Injection moulded construction, durable and leak proof
- Compatible with 200mm x 200mm plates
- Simple to use casting
- Rapid set up and cooling

Technical Specification

Dimensions, plate [l x w], mm	200 x 200
Dimensions [l x w x h], mm	300 x 180 x 270
Capacity	48 samples per gel
Volume, mL	640 to 5,300 (buffer)
No. of samples	1, 5, 10, 18MC, 24, 30, 36MC, 48
Thickness, mm	0.5, 1.0, 1.5, 2.0

MC = Multichannel pipettor compatible

Cat. No	Description
12623546	Verti-Gel Maxi Dual PAGE System 200mm x 200mm, cooling coil & caster, 2x plain glass plates with 1mm bonded spacers, 2x notched glass plates, 2x 24 sample combs (1mm)
15126644	Verti-Gel Maxi Dual electroblotting system, 200mm x 200mm, with cooling coil and caster, 2x plain glass plates with 1mm bonded spacers, 2x notched glass plate, 2x 24 sample combs (1mm)



Combs and Accessories

Combs	Thickness 0.75mm		Thickness 1.0mm		Thickness 1.5mm		Thickness 2.00mm	
	Cat. No	Sample size, µL	Cat. No	Sample size, µL	Cat. No	Sample size, µL	Cat. No	Sample size, µL
1 prep, 1 marker	11807813	1,100	11857813	1,500	11867813	2,200	11877813	3,000
5 sample	11887833	160	11897833	200	11807843	320	11817843	400
10 sample	11817813	80	11827813	100	11837813	160	11847813	200
18 sample MC	11887813	40	11897813	50	11807823	80	11817823	100
24 sample	11827823	30	11837823	40	11847823	60	11857823	80
30 sample	11867823	25	11877823	35	11887823	50	11897823	70
36 sample MC	11807833	20	11817833	25	11827833	40	11837833	50
48 sample	11847833	15	11857833	20	11867833	30	11877833	40

Cat. No	Description	Pack qty
Accessories - General		
15166624	Verti-Gel Maxi external casting stand	1
15196624	Verti-Gel Maxi page insert	1
15106634	Detachable cooling coil, Verti-Gel Maxi	1
15186624	Verti-Gel Maxi casting base	1
11864672	Replacement rubber mat for 200mm caster	2
15126634	Tank, Verti-Gel Maxi	2
15136634	Verti-Gel Maxi lid (no cables)	2
15146634	Electrophoresis cable (black & red)	2
11884532	Plain glass plates	2
11894532	Plain plates 0.75mm spacers	2
11804542	Plain plates 1mm spacers	2
11814542	Plain plates 1.5mm spacers	2
11824542	Plain plates 2mm spacers	2
11854532	Notched plates	2
11864532	Notched plates 0.75mm spacers	2
11874532	Notched plates 1mm spacers	2
11854502	Dummy plate, 200mm x 200mm	1
11884502	Maxi cooling block	2
11834542	Spacers, 200mm x 0.75mm thick	2
11844542	Spacers, 200mm x 1mm thick	2
11854542	Spacers, 200mm x 1.5mm thick	2
11864542	Spacers, 200mm x 2mm thick	2
11887803	Replacement platinum wire 1m x 0.2mm	1
Accessories - Blotting		
15106644	Maxi blotting module, Verti-Gel Maxi	1
12348007	Maxi blotting cassette, Verti-Gel Maxi	1
12358007	Maxi fibre pad	1
15116644	Maxi high intensity blotting module, Verti-Gel Maxi	1
Accessories - 2D Electrophoresis		
15186634	Maxi tube gel module, Verti-Gel Maxi	1
15116634	IEF conversion kit for Verti-Gel Maxi	1
15196634	Mini capillary tubes	10
11867653	Maxi capillary blanking ports	10

Don't forget your power supplies, these can be found on page 46 to 49



FISHER BIOREAGENTS FOR VERTICAL GEL ELECTROPHORESIS



Once again Fisherbrand and Fisher Bioreagents have combined to provide a complete range of products for your electrophoresis needs. This section details essential bioreagents such as PAGE buffers, detergents and denaturing reagents as well protein standards. Fisherbrand and Fisher Bioreagents are manufactured to the highest standard and are committed to delivering quality, reliable products at affordable prices.

The SDS-PAGE technique has been refined over the years (see timeline representation below). For example, specialised gel systems such as porosity gradient gels and Tricine-SDS-PAGE were developed to expand the M_r analysis range and to improve the resolution of small proteins, respectively. Many would agree that improvements to the technique have now reached a plateau and standard protocols have been adopted in most laboratories around the world.

However, as the next evolutionary step forward, Fisher Bioreagents EZ-Run Protein Gel Solution is a simple, continuous gel system for SDS-PAGE that provides the resolution of a gradient gel with less preparative work than the Laemmli discontinuous gel system. It is a premixed solution of acrylamide, bis-acrylamide, buffer and SDS that eliminates the need of a stacking gel. The gradient-like properties of the EZ-Run gel matrix slow the migration of proteins through the electrophoretic field, enabling the resolution of small peptides and large proteins on the same gel.

Advances in SDS-PAGE for characterisation of proteins

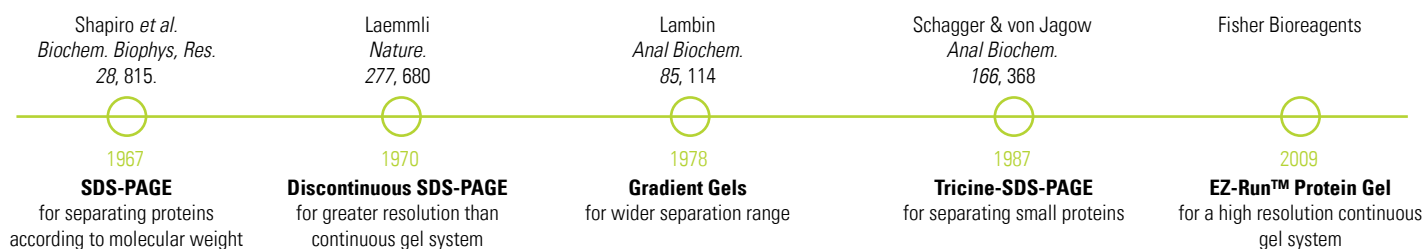

EZ-Run Protein Gel Solution



- Ready to use
- Superior resolution
- Wide separation range on same mini gel
- No stacking gel required
- Proprietary gel chemistry
- Stable for two years at room temperature
- Compatible with all conventional staining methods
- Suitable for post-electrophoresis applications such as Western blot transfer and MALDI analysis

EZ-Run Protein Gel Solution is a unique ready to pour premixed solution of acrylamide, buffer, and SDS that enables superior resolution of protein bands by SDS-PAGE. The liquid blend requires only the addition of ammonium persulfate and TEMED to prepare a quality gel matrix for SDS-PAGE. The proprietary gel chemistry imparts gradient-like properties to the polymerised gel matrix, enabling the separation of small peptides and high molecular weight proteins on the same mini gel.

EZ-Run gel matrix is used as a simple, continuous gel system and does not require a stacking gel, which saves labour and time in casting. EZ-Run gel separates small proteins like Tricine-SDS-PAGE and has a wide separation range similar to gradient gels (3 to 200kDa on the same mini gel).

EZ-Run gels are compatible with all standard electrophoresis equipment as well as common staining methods such as Coomassie blue, silver stain, and fluorescent dyes. Post-electrophoresis techniques such as Western blot transfer, protein sequencing and MALDI analysis can also be applied to proteins separated on EZ-Run gels.

Cat. No	Description	Quantity
10274673	Acrylamide:Bis-acrylamide, protein gel solution, EZ-Run 10%	100mL
10284673	Acrylamide:Bis-acrylamide, protein gel solution, EZ-Run 10%	500mL
10678393	Acrylamide:Bis-acrylamide, protein gel solution, EZ-Run 12.5%	500mL
10678583	Acrylamide:Bis-acrylamide, protein gel solution, EZ-Run 15%	100mL
10284913	Acrylamide:Bis-acrylamide, protein gel solution, EZ-Run 15%	500mL
10366883	EZ-Run buffered protein gel solution 20X	500mL

EZ-Run Protein Gel Solution Separation Range:

EZ-Run Gel %	MW Separation Range (kDa)
10	10 to 220
12.5	3 to 200
15	2 to 100

4 to 20% PRECAST GRADIENT GEL

12.5% EZ-Run GEL

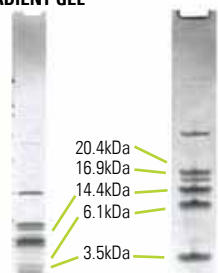

12% PRECAST GEL

12.5% EZ-Run GEL

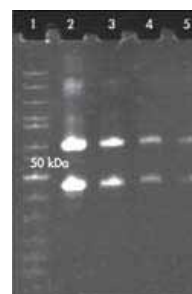
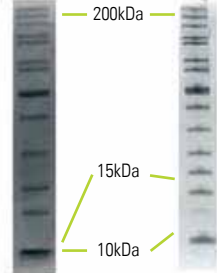

Resolution equal to or better than gradient precast gels!

EZ-Run Protein Gel Solution provides superior separation of closely spaced, small proteins (<20kDa) compared to a commercial gradient precast gel.

Separate wide range of protein sizes (3 to 200kDa) on the same mini gel

The EZ-Run continuous gel system enables separation of small peptides and high MW proteins on the same mini gel. For example, a commercial 12% precast discontinuous gel is not capable of resolving the 10 and 15kDa proteins compared to the 12% EZ-Run gel.

EZ-Run gel matrix compatible with common gel staining methods such as fluorescent dyes

Serial dilutions of BSA (66kDa) and Ovalbumin (45kDa) are loaded in lanes 2 to 5 of an EZ-Run gel and detected with SYPRO™ Ruby fluorescent protein stain. Protein standard in lane 1 is Cat. No 11498503 EZ-Run Recombinant Protein Ladder.

EZ-Run Protein Standards Solution



Designed to assist in characterising unknown proteins in polyacrylamide gels and immunoblots.

- Highly purified markers and ladders provide compact and clear bands
- Prestained standards are indispensable in monitoring protein separation and transfer efficiency
- Reference bands allow quick gel progress assessment
- Unstained standards are most suitable for precise sizing of proteins
- All standards are supplied in loading buffer and are ready to use

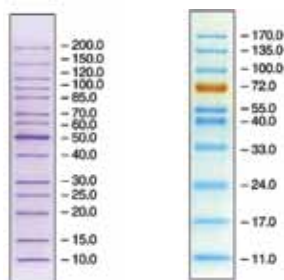

Cat. No	Description	Pack qty
11438513	Protein marker for SDS PAGE, EZ-Run, 14.4 to 116.0kDa, 7 bands, 100 loadings (0.5mL)	1
11874684	Protein marker for SDS PAGE, EZ-Run, 14.4 to 116.0kDa, 7 bands, 200 loadings (0.5mL)	2
11498503	Protein ladder, recombinant for precise sizing on SDS PAGE/Western blots, EZ-Run, 10 to 200kDa, 14 bands, 100 loadings (0.5mL)	1
11864684	Protein ladder, recombinant for precise sizing on SDS PAGE/Western blots, EZ-Run, 10 to 200kDa, 14 bands, 200 loadings (0.5mL)	2
11418513	Protein marker, prestained for SDS PAGE, EZ-Run, 20 to 118kDa, 6 bands, 100 loadings (0.5mL)	1
11879694	Protein marker, prestained for SDS PAGE, EZ-Run, 20 to 118kDa, 6 bands, 200 loadings (0.5mL)	2
11478503	Protein ladder, prestained, recombinant for SDS PAGE/Western blots, EZ-Run, 10 to 170kDa, 10 bands, 100 loadings (0.5mL)	1
11869694	Protein ladder, prestained, recombinant for SDS PAGE/Western blots, EZ-Run, 10 to 170kDa, 10 bands, 200 loadings (0.5mL)	2

EZ-Run Protein Gel Staining Solution



Highly sensitive, non-toxic.

- Detects as little as 5ng protein
- Produces minimal or no background
- Permits rapid staining/destaining (30 minute staining and one hour destaining in water is sufficient for most applications)
- Contains Coomassie Brilliant Blue G-250
- Does not contain methanol or acetic acid
- Ready to use

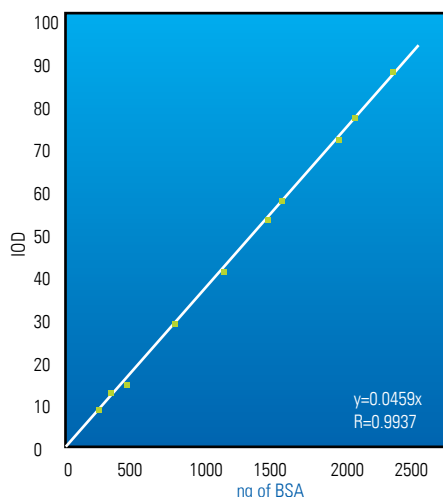

Linear range of protein detection using Cat. No 10786444

EZ-Run Protein Gel Staining Solution

Band intensity was measured and plotted against the amount of protein (BSA) loaded per gel lane. The result shows a linear dynamic range from 5ng to 2,000ng using EZ-Run Protein Gel Staining Solution.

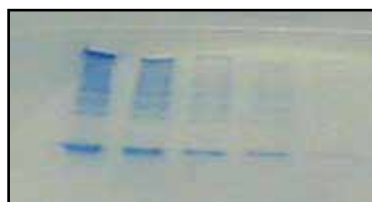

EZ-Run Protein Gel Staining Solution

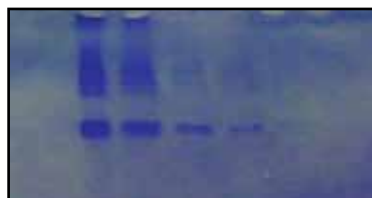

Conventional Coomassie Blue Staining

Destaining of EZ-Run Protein Gel Staining Solution

Compared to conventional Coomassie Blue staining, the EZ-Run stain produces very clean backgrounds using only water for destaining.



Staining sensitivity with EZ-Run Protein Gel Staining Solution

Serial dilution of BSA on 10% SDS-PAGE demonstrating staining sensitivity of EZ-Run Protein Gel Staining Solution.

Cat. No	Description	Quantity
10786444	Protein gel staining solution, EZ-Run, colloidal Coomassie Blue G250	1L
10609933	Protein gel staining solution, EZ-Run, colloidal Coomassie Blue G250	4L

One litre of EZ-Run Protein Gel Staining Solution is sufficient for 50 mini gels

Buffers for Protein Electrophoresis



Cat. No	Description	Quantity
10746834	Tris-glycine solution 10X DNase, RNase and protease free	1L
10356743	Tris-glycine solution 10X DNase, RNase and protease free	4L
10437773	Tris-glycine 10X powder will make 1L of 10X solution DNase and RNase free	1L*
10051653	Tris-glycine-SDS solution 10X DNase, RNase and protease free	1L
10102823	Tris-glycine-SDS solution 10X DNase, RNase and protease free	4L
10618203	SDS-PAGE buffer for protein electrophoresis, dry powder mix of Tris-Glycine-SDS makes 1L 5X buffer, 92g pack electrophoresis tested	1L
10061653	Tris-glycine-SDS buffer, 10X powder	1L
10468543	PBS (Phosphate Buffered Saline) solution 10X DNase, RNase and protease free	500mL
10204733	PBS (Phosphate Buffered Saline) solution 10X DNase, RNase and protease free	1L
10214733	PBS (Phosphate Buffered Saline) solution 10X DNase, RNase and protease free	4L
10649743	PBS (Phosphate Buffered Saline) solution 10X DNase, RNase and protease free	20L
10388739	PBS tablets (Phosphate Buffered Saline), 1 x tablet dissolved in 200mL water yields 0.01M phosphate buffer, 0.0027M KCl, and 0.137M NaCl, pH 7.4 at 25°C	100 tab**
10869020	PBS with TWEEN, supplied in pouches, each makes 1L*	10 foil pouches
10648973	Tris buffered saline (TBS) 10X solution pH 7.4	100mL
10153103	Tris buffered saline (TBS) 10X solution pH 7.4	500mL
10776834	Tris buffered saline (TBS) 10X solution pH 7.4	1L
10103203	Tris base DNase, RNase protease free, electrophoresis tested	500g
10376743	Tris base DNase, RNase protease free, electrophoresis tested	1kg
10724344	Tris base DNase, RNase protease free, electrophoresis tested	5kg
10667243	Tris base DNase, RNase protease free, electrophoresis tested	10kg
10336793	Tris base DNase, RNase protease free, electrophoresis tested	25kg
10467963	Glycine	500g
10061073	Glycine	1kg
10754724	Glycine	5kg

*Pre-weighed powder to make 1L. Dissolve in water.

**One tablet dissolved in 200mL water yields 0.01M phosphate buffer, 0.0027M KCl, and 0.137M NaCl, pH 7.4 at 25°C

Acrylamide, Bis-Acrylamide and Catalysts



Cat. No	Description	Quantity
10562595 [†]	Acrylamide white crystals	100g
10235203 [†]	Acrylamide white crystals	500g
10502605 [†]	Acrylamide white crystals	5kg
10688963 [†]	Acrylamide solution 40% DNase, RNase protease free, electrophoresis tested	1L
10689923 [†]	Bis-acrylamide DNase, RNase and protease free	25g
10689733 [†]	Bis-acrylamide DNase, RNase and protease free	100g
10193523	Bis-acrylamide solution 2% w/v DNase, RNase and protease free	250mL
10786644	Acrylamide:Bis-Acrylamide 19:1 powder DNase and RNase free, electrophoresis tested	100g
10699933	Acrylamide:Bis-Acrylamide 29:1 powder DNase and RNase free, electrophoresis tested	100g
10001073	Acrylamide:Bis-Acrylamide 37.5:1 powder DNase and RNase free, electrophoresis tested	100g
10214963	Acrylamide:Bis-Acrylamide 19:1 solution 40% DNase and RNase free, electrophoresis tested	1L
10001313	Acrylamide:Bis-Acrylamide 29:1 solution 40% DNase and RNase free, electrophoresis tested	1L
10376643	Acrylamide:Bis-Acrylamide 37.5:1 solution 40% DNase and RNase free, electrophoresis tested	1L
10081503 [†]	Ammonium persulfate crystals	25g
10396503 [†]	Ammonium persulfate crystals	100g
11423094 [†]	Sodium persulfate >98% white crystalline powder	1kg
10689543 [†]	TEMED (N,N,N',N'-Tetramethylethylenediamine) electrophoresis tested	20g
10142863 [†]	TEMED (N,N,N',N'-Tetramethylethylenediamine) electrophoresis tested	100g

Detergents/Denaturing Reagents



Cat. No	Description	Quantity
10366553 [†]	Brij 35	500g
10659163 [†]	CHAPS	1g
10274723 [†]	CHAPS	5g
10593335	Sodium dodecyl sulfate (SDS) powder	100g
10356463	Sodium dodecyl sulfate (SDS) powder	500g
10593355	Sodium dodecyl sulfate (SDS) powder	5kg
10265153 [†]	Sodium dodecyl sulfate (SDS) solution 10% DNase, RNase and protease free for molecular biology	200mL
10552785 [†]	Sodium dodecyl sulfate (SDS) solution 10% DNase, RNase and protease free for molecular biology	1L
10607633 [†]	Sodium dodecyl sulfate (SDS) solution 20% DNase, RNase and protease free, for molecular biology	200mL
10607443 [†]	Sodium dodecyl sulfate (SDS) solution 20% DNase, RNase and protease free, for molecular biology	1L
10102913 [†]	Triton X-100	100mL
10254583 [†]	Triton X-100	500mL
10113103	Tween 20	100mL
10485733	Tween 20	500mL
10592955	Tween 80	500mL

[†] Refer to page 67, GHS hazard information.



PRODUCING YOUR OWN STOCK SOLUTIONS FOR VERTICAL GEL ELECTROPHORESIS

30% Acrylamide Gel Solution

Fisher Bioreagents



- Acrylamide..... (Cat. No 10235203)[†]
- Bis-acrylamide..... (Cat. No 10689923)[†]
- Water..... (Cat. No 10336503)

Equipment and consumables **Fisherbrand**



Water baths
page 66

pH meters
page 61

Measuring cylinders
page 55

Amber bottles
page 63

Method

Dissolve 29g acrylamide and 1g bis-acrylamide in a total volume of 60mL distilled deionised water.

Gently heat the solution (at approximately 37°C) and stir until the acrylamide and bis-acrylamide have dissolved.

Adjust the final volume to 100mL with distilled deionised water and stir.

Filter the solution through a 0.45µm membrane filter.

Adjust the pH to 7.0 or less using HCl.

Store the solution in dark bottles at room temperature for less than 3 months.

4X Gel Buffers (Stock Solution)

Fisher Bioreagents



- Tris base (Cat. No 10376743)
- Sodium Dodecyl Sulfate (SDS)..... (Cat. No 10356463)
- Water..... (Cat. No 10336503)
- HCl (Cat. No 10447450)[†]

Equipment and consumables **Fisherbrand**



Beakers
page 55

Stirrers
page 59

Magnetic followers
page 59

pH meter
page 61

Method

Buffer type	Tris base (g)	SDS (g)	Distilled deionised water (add to)	Adjust the pH to (with HCl)	Add water to
Stacking (upper buffer)	15.14	1	150mL	6.8	250mL
Resolving (lower buffer)	45.41	1	150mL	8.8	250mL

In a beaker add the Tris, SDS and water according to the volumes outlined in the above table.

Mix thoroughly.

Adjust the pH to 6.8 or 8.8 using HCl.

Store at +4°C.

10X SDS-PAGE Running Buffer (Stock Solution)

Fisher Bioreagents



- Tris base (Cat. No 10376743)
- Sodium Dodecyl Sulfate (SDS)..... (Cat. No 10356463)
- Glycine..... (Cat. No 10754724)
- Water..... (Cat. No 10336503)

Equipment and consumables



Bottles
page 55

Beakers
page 55

Measuring cylinders
page 55

pH meters
page 61

Method

Weigh out 30.3g Tris base, 144.0g glycine and 10g SDS.

Make up to 1L with distilled water.

No need to adjust pH (should be approximately pH 8.3).

1X SDS-PAGE Running Buffer (Working Solution)

Method

Dilute stock solution by 10X in distilled water. Final concentrations are :

- 25mM Tris pH 7.6
- 192mM glycine
- 0.1% SDS



1M Tris-HCl, pH 6.8

Fisher Bioreagents 

- Tris base (Cat. No 10376743)
- Water..... (Cat. No 10336503)
- HCl..... (Cat. No 10447450)[†]

Equipment and consumables **Fisherbrand**



Bottle
page 55



Beakers
page 55



Measuring cylinders
page 59

Method

Weight 12.11 g of Tris base and add to 80mL of water.
Adjust to desired pH with HCl.
Adjust the final volume to 100mL with distilled water.

10% AP (Ammonium Persulfate solution)

Fisher Bioreagents 

- Ammonium Persulfate..... (Cat. No 10081503)[†]
- Water..... (Cat. No 10336503)

Equipment and consumables **Fisherbrand**



Elite pipettors
page 56



SureOne™ tips
page 57



1.5mL centrifuge tubes
page 52

Method

Weigh out 0.1g ammonium Persulfate.
Dissolve in 1mL distilled water.
Store at +4°C for 2 to 3 weeks.

Sample Loading Buffer (4X Stock)

Fisher Bioreagents 

- 1M Tris-HCl (pH 6.8)..... (refer to recipe for 1M Tris-HCl)
- Sodium Dodecyl Sulfate (SDS)..... (Cat. No 10356463)
- Glycerol..... (Cat. No 10021083)
- β-mercaptoethanol..... (Cat. No 10366313)[†]
- 0.5M EDTA..... (Cat. No 10618973)[†]
- Bromophenol Blue..... (Cat. No 10532965)

Equipment and consumables **Fisherbrand**



Elite pipettors
page 56



SureOne™ tips
page 57



1.5mL centrifuge tubes
page 52



Safety gloves
page 65

Method

Weigh out 0.8g SDS and 8mg bromophenol blue.
Add 2mL of Tris-HCl and 4mL glycerol.
Pipette 0.4mL β-mercaptoethanol and 1mL EDTA.
Adjust final volume to 10mL with distilled water.
Aliquot into 1.5mL microcentrifuge tubes and store at -20°C.

Dilute protein sample 1:3 into 4X sample loading buffer.

[†] Refer to page 67, GHS hazard information.

BLOTTING

Blotting, a technique that entails immobilisation of proteins or nucleic acids on a solid membrane support and then detection using a specific antibody or probe of complementary nucleic acid sequence, significantly increases the potential for identification and characterisation of proteins and nucleic acids. Upon transfer to a membrane support, proteins and nucleic acids become far more accessible to detection by antibodies and probes than they would otherwise be within a gel. Size fractionation by gel electrophoresis followed by blotting is an excellent way to identify specific molecules within a mixed population of nucleic or protein molecules, and the two techniques are often used in tandem.

With both the Fisherbrand Mini and Maxi Verti-Gel units, optional blotting modules are available (Cat. No 11837623 and 15106644 respectively). Alternatively, they are available as part of a fully integrated system for multiple electrophoresis techniques (refer to pages 30 and 34).

Semi Dry Blotter

- Rapid transfer times
- Western, Southern and Northern blots
- Economic transfers due to very low buffer volumes
- Screw down lid
- Gels from 0.25 up to 10mm thick can be blotted
- Uniform heat dispersion
- Long life electrodes

Semi dry blotters offer rapid transfer times for DNA, RNA and protein blotting – typically 15 to 30 minutes. It can be used for all types of blotting: Western, Southern and Northern via uncomplicated buffer and set up procedures and is compatible with gel thicknesses from 0.25mm up to 10mm without the need for additional equipment. Semi dry blotting has the added benefit of economic transfers due to very low buffer volumes – typically only a few millilitres of buffer are required per transfer. The semi dry blotters utilise a screw down lid, which secures the blot sandwich and allows complete control of pressure ensuring even transfer. The electrodes, comprising a platinum coated anode and stainless steel cathode, will exhibit practically no corrosion and so provide many years of trouble free use. Uniform heat dispersion across the blot sandwich ensures stable transfer times and no heat induced sample loss or transfer distortions. Electrode plates are fully separated to prevent arcing or damage.

Cat. No	Description
12367297	Semi dry blotter, Maxi



Don't forget your power supplies, these can be found on page 46 to 49



Slab Gel Dryers

- Dries 330mm x 500mm sequencing gels in as little as 30min
- Dries multiple small format gels quickly
- Even heat distribution via an 800W heating membrane
- Accurate temperature control up to 90°C
- 5hr timer for heating element and vacuum pump, in 1min steps
- Clear cover for viewing of the drying process

Two versatile vacuum gel dryers, which can accommodate any size of gel up to either 340mm x 450mm or the large format 500mm x 400mm. The units are of extremely robust construction. The base is of cast aluminium with a heat resistant coating for protection and to assist with the even distribution of heat. The user friendly control panel is constructed from stainless steel for strength. Although solidly built the units are extremely light for easy transportation.

Requires a suitable vacuum pump/source, see below (Cat. No 15168886)

Cat. No	Description
10400893	Slab gel drying system, 450mm x 340mm. Includes: stainless steel screen, Mylar™ sheet, porous polyethylene sheet, clear silicone rubber overlay sheet
10599781	Slab gel drying system, 500mm x 400mm. Includes: stainless steel screen, Mylar™ sheet, porous polyethylene sheet, clear silicone rubber overlay sheet



Cat. No	Description
Accessories - General	
10589391	Stainless steel sieve for gel dryer
11784306	Mylar sheet for Cat. No 10400893
11750045	Porous polypropylene sheet for Cat. No 10400893
11739665	Silicon rubber overlay for Cat. No 10400893
12368546	Mylar sheet for for Cat. No 10599781
12378546	Porous polypropylene sheet for Cat. No 10599781
12388546	Silicon rubber overlay for Cat. No 10599781

Vacuum System for Gel Dryers

- Less than 8mbar ultimate pressure
- 16L/18L per min flow rate
- With PTFE diaphragm, inlet catchpot, exhaust emission condenser, vacuum regulator and digital vacuum gauge, fully mounted

Cat. No	Description
15168886	Vacuum system



TECHNICAL RESOURCES



TechSupport

Here to give you a helping hand!

Fisher Scientific's Product Support Team is your dedicated resource. Our Product Support Advisors are all highly qualified professionals who are here to support and guide you to the fastest, most effective and efficient answer to your enquiry.

Areas of technical expertise include:

- Bioreagents and Life Science
- Chemicals and Chromatography
- Consumables
- Equipment
- Safety

This section features a helpful troubleshooting guide and FAQ's. If, however, this information does not resolve the issue, or if you have questions not covered below

Contact our Product Support Advisors
Tel: 01509 555888
Email: fisheruk.productsupport@thermofisher.com

Vertical Gel Unit Troubleshooting Guide

The following table lists some of the most commonly experienced problems with vertical gel units along with useful suggestions for solving them.



Problem	Cause	Suggestions
Poor protein transfer	Transfer apparatus assembled incorrectly and proteins moving in the wrong direction	<ul style="list-style-type: none"> • Gel/membrane sandwich may be assembled in the wrong order, or cassette inserted in wrong orientation. Check polarity
	Western detection system not working or not sensitive enough	<ul style="list-style-type: none"> • Include proper positive or negative control antigen. Consult kit manual • Use protein markers with coloured reference bands during PAGE • Stain gel with Coomassie, or stain membrane with Ponceau S
	Transfer time too short	<ul style="list-style-type: none"> • Increase transfer time
	Power setting too low	<ul style="list-style-type: none"> • Check current at beginning of run. Current may be too low for a given voltage setting. Increase current if necessary but do NOT exceed 2,000mA • Buffer may be prepared improperly – prepare new buffer and increase voltage
	Charge-to-mass ratio incorrect for native transfers	<ul style="list-style-type: none"> • Proteins close to isoelectric point (pI). Change buffer pH so that it is at least 2 pH units higher or lower than pI of protein of interest
	Defective or inappropriate power supply used	<ul style="list-style-type: none"> • Check fuse of power supply. Ensure max. current output of power supply is at least 2,000mA
	Excessive methanol restricting transfer	<ul style="list-style-type: none"> • Reduce methanol concentration to maximise protein transfer from gel, but without reducing concentration to the extent that it prevents binding to nitrocellulose. Alternatively reduce methanol concentration and switch to PVDF

Vertical Gel Electrophoresis

Problem	Cause 	Suggestions 
Protein precipitating in gel	Protein precipitating in gel	<ul style="list-style-type: none"> Use SDS in transfer buffer (SDS can increase transfer efficiency, but it can also reduce nitrocellulose binding affinity and affect protein-antibody reactivity) Remove alcohol from transfer buffer
Swirls or missing bands; diffuse transfers	Poor gel-membrane contact. Air bubbles or excess buffer remain between membrane and gel	<ul style="list-style-type: none"> Carefully remove air bubbles between gel and membrane using a rolling pin Use more, or thicker, filter paper in gel membrane sandwich Replace the fibre pads, as they degrade and remain permanently compressed over time
	Membrane not fully wet or has dried out	<ul style="list-style-type: none"> If soaking does not occur immediately following immersion in transfer buffer, heat distilled water to just below boiling point and soak membrane until entirely wet If using PVDF, immerse membrane in methanol before soaking in transfer buffer
	Problem with gel electrophoresis	<ul style="list-style-type: none"> Poor gel polymerisation Inappropriate running conditions Buffer contamination Excessive sample application all contribute to poor quality gels and transfers
Gel cassette pattern transferred to blot	Contaminated fibre pads	<ul style="list-style-type: none"> Replace fibre pads or clean thoroughly. Contaminated transfer buffer Replace buffer solutions
Poor binding to membrane - nitrocellulose	Excessive methanol restricting transfer	<ul style="list-style-type: none"> Ensure methanol concentration does not exceed 20% (v/v)
	Proteins may be transferring through nitrocellulose	<ul style="list-style-type: none"> Use PVDF or smaller pore size (0.2µm) nitrocellulose Overlay an extra piece of nitrocellulose over membrane to determine if proteins are migrating through the membrane directly in contact with the gel
	Proteins <15kDa have reduced binding to 0.45µm nitrocellulose or may be washed from membrane during assays	<ul style="list-style-type: none"> Use PVDF or nylon membrane, which have higher binding capacities Use Tween-20 detergent in the wash and antibody incubation steps. Reduce or eliminate the more stringent washing steps
	SDS in transfer buffer reducing binding efficiency	<ul style="list-style-type: none"> Reduce or eliminate SDS concentration
Poor binding to membrane - PVDF	Membrane is not completely wet	<ul style="list-style-type: none"> White spots indicate dry areas where protein will not bind If soaking does not occur immediately following immersion in transfer buffer, heat distilled water to just below boiling point and soak membrane until entirely wet
	Membrane is not completely wet	<ul style="list-style-type: none"> Because of hydrophobicity of PVDF, the membrane must be soaked entirely in methanol before equilibration in aqueous buffer
	Proteins might be transferring through the membrane	<ul style="list-style-type: none"> Decrease voltage if transferring under high intensity conditions Overlay an extra piece of PVDF over membrane to determine if proteins are migrating through the membrane directly in contact with the gel
	Membrane might have dried during handling	<ul style="list-style-type: none"> Fully wet membranes have a grey translucent appearance. White spots will form on the surface if the membrane has been allowed to dry. As proteins will not bind to dry spots, re-soak the membrane in methanol and re-equilibrate in transfer buffer
SDS in transfer buffer reducing binding efficiency		<ul style="list-style-type: none"> Reduce or eliminate SDS concentration
Power	Power is too high	<ul style="list-style-type: none"> Always check current at the start of the run, for the current might be too high for a given voltage setting. Improper buffer preparation can also result in high conductivity and excessive power generation. The current setting should not be allowed to exceed 2,000mA
Immune-specific detection	Overall high background	<ul style="list-style-type: none"> Reduce antibody/protein sample concentration Too low background Increase antibody concentration/protein sample concentration Consult manual included with antibody detection kit
Total protein detection	Total protein detection	<ul style="list-style-type: none"> Consult stain or detection kit manual

Frequently asked questions (FAQ's) – Vertical Gel Electrophoresis

This section lists the most frequently asked questions received by our Life Science and Chemical Specialists, together with the answers they provided (also refer to pages 22 to 23 and 51). If you are unable to find the answer to your question, are stuck and need help or are simply confused and unsure of which product best suits your research needs, the Product Support Team are here and ready to respond to your enquiries

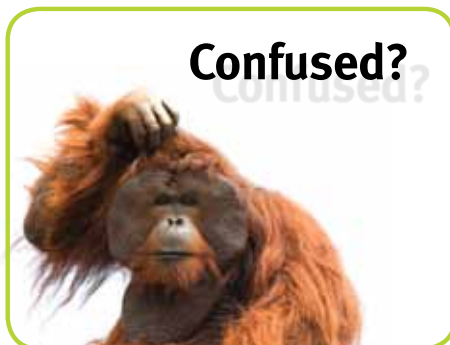

Contact our Product Support Advisors

Tel: 01509 555888

Email: fisheruk.productsupport@thermofisher.com

Q. What percentage acrylamide gel should I use?

A. Care should be taken when selecting the percentage acrylamide or pore size of the gel to be used. The table below details which percentage of gel to use to separate the sizes of proteins indicated.

Acrylamide Percentage	Separating Resolution
5%	60 to 220kDa
7.5%	30 to 120kDa
10%	20 to 75kDa
12%	17 to 65kDa
15%	15 to 45kDa
17.5%	12 to 30kDa

Q. Does the protein gel loading dye (Cat. No 10376363) contain any reducing agents such as β -mercaptoethanol or DTT?

A. For protein gel electrophoresis, typical sample loading buffers are available in either a reducing or non-reducing formulation. Dithiothreitol (DTT) is a common reducing agent used in protein sample buffers. The formulation of Fisher Bioreagents Cat. No 10376363, protein gel loading dye (2X), does not contain a reducing agent such as DTT.

Q. Is it possible to autoclave Cat. No 10204733?

A. It is not advisable to autoclave Fisher Bioreagent Cat. No 10204733, 10X PBS, as phosphate may precipitate out. For this product, we filter the buffer solution through a 0.2micron filter into a sterile 1L poly bottle under a sterile hood.

Q. Do you have the formulation for Cat. No 10649743?

A. The formulation of Fisher Bioreagents Cat. No 10649743 Phosphate Buffered Saline (PBS), 10X solution is as follows:

- 1.37M Sodium Chloride
- 0.027M Potassium Chloride
- 0.119M Phosphate Buffer

The phosphate buffer consists of two components, namely 0.101M sodium phosphate dibasic heptahydrate (CAS # 7782-85-6) and 0.018M potassium phosphate monobasic (CAS # 7778-77-0).

Q. Why is the actual band size on a Western blot different from the predicted size of the protein?

A. Western blotting is based on the separation of proteins by their size on a gel. However, migration of proteins through the gel matrix is also affected by other factors, which may cause the observed band size to be different from the predicted size.

Vertical Gel Electrophoresis

Common causes are:

- Post-translational modification; for example phosphorylation and glycosylation increase the size of the protein
- Post-translation cleavage; many proteins are synthesised as precursor proteins, and then cleaved to give the active form
- Multimers, for example dimerisation of a protein. This is usually prevented under reducing conditions, although strong interactions can result in the appearance of higher bands
- Splice variants; alternative splicing may result in different sized proteins being produced from the same gene
- Relative charge; the composition of amino acids (charged vs. non-charged)

Q. What is the best method for staining SDS-PAGE gels?

A. Coomassie staining is probably one of the most well known protein staining techniques. Two main Coomassie staining methods exist, "classical" Coomassie and the more recently developed colloidal Coomassie.

- Classical Coomassie involves staining the whole gel, not just the proteins. By destaining the gel, proteins are visualised as the dye is retained better by the proteins than the gel. It's sensitivity (detection limit) is approx. 100ng, which makes detection of low abundant proteins difficult. It is simple, cheap and quick to perform and has the advantage of being compatible with mass spectrometry. However, reproducibility is an issue with this stain due to challenges in standardising the destaining step
- Colloidal Coomassie is an adaptation of classical Coomassie staining using a modified Coomassie dye (G-250 instead of R-250). It has increased sensitivity compared to classical Coomassie, with a detection limit of approx. 10ng. It is simple to perform and since the colloidal dye does not penetrate the gel, destaining is not required (though can be performed to improve background). As with classical Coomassie it is compatible with mass spectrometry

In addition to Coomassie staining, silver staining is another popular method for visualising proteins. The main benefit of silver staining is its high sensitivity as you are able to detect less than 1ng protein, making it the preferred stain for detection of low abundance proteins. However, silver staining is time consuming and laborious. The gel requires developing after staining, in order to visualise the proteins, and the length of time for developing can vary considerably between gels making reproducibility a challenge. Silver staining also involves the use of formaldehyde when fixing the gel making it incompatible with mass spectrometry.

Q. Can I stain with Coomassie Blue and then Western blot?

A. Yes, it is possible to stain with either Coomassie or Colloidal Blue stain prior to Western blotting, though decreased transfer and subsequent probing efficiency may occur. However, it is important to note that this is generally only recommended to try if you use colloidal stain. To ensure optimal transfer efficiency, destain the gel and then equilibrate in a series of Tris base/glycine/SDS solutions to increase solubility. When the transfer is complete, the membrane should be treated with methanol to remove the stain prior to chromogenic development (not necessary prior to chemiluminescent detection).

Q. How can I improve transfer efficiency for larger proteins during Western blotting?

A. Here are some options for obtaining more efficient transfer for larger proteins:

- 1) Pre-equilibrate the gel with 0.02 to 0.04% SDS in 2X transfer buffer without methanol for 10mins before assembling the sandwich
- 2) Increase the blotting time incrementally (in 15min intervals)
- 3) Add 0.01% or 0.02% SDS to the transfer buffer to help facilitate the migration of the protein out of the gel
- 4) Decrease the methanol content in the transfer buffer
- 5) Switch to a more appropriate lower percentage gel. A lower percentage gel may allow better transfer than a higher percentage gel

Q. How can I improve the transfer efficiency of protein ladders when Western blotting onto a PVDF membrane?

A. There are two factors to consider - poor transfer and the ladder passing through the membrane during the transfer.

For poor transfer onto membrane, consider the following:

- The percent acrylamide should be 8% to get rapid, more complete transfer of high molecular weight proteins
- Increase voltage, current, or length of time for transfer
- For transfer to PVDF, omit the SDS from the transfer buffer. Addition of SDS (or use of old buffer that may have SDS leached in from the gel) will cause the proteins to bind less efficiently to PVDF membranes because it inhibits the hydrophobic interaction between the membrane and the protein
- If the problem is the protein staying in the gel, consider any of the following:
 - Increase the SDS concentration to 0.1% (but use nitrocellulose)
 - Eliminate the methanol in the buffer
 - Reduce the acrylamide percentage
 - Transfer for longer

If the ladder goes through membrane during transfer:

- Decrease voltage or transfer
- Check concentration of SDS and methanol. Too much SDS can prevent binding to the membrane. Alcohol enhances hydrophobic binding to membrane; not enough alcohol may prevent binding
- Use a 0.2µm pore size of nitrocellulose
- Check gel percentage; smaller proteins will pass through membranes more easily

Q. What are the standard lysis buffers used with mammalian cells for detection of protein expression by immunoprecipitation or Western blot analysis?

A. The most commonly used buffer is RIPA buffer with SDS. The usual formulation is as follows:
150mM NaCl, 10mM Tris, pH 7.2, 0.1% SDS, 1.0% Triton X-100, 1% Deoxycholate, 5mM EDTA
Protease inhibitors: 1mM phenylmethylsulfonyl fluoride, 10mM benzamidine, 2µg/mL leupeptin
Phosphatase inhibitors: 100µM sodium orthovanadate, 10mM p-nitrophenylphosphate

Procedure:

1. Place cells on ice
2. Wash cells with ice cold PBS to remove media
3. Add 1mL RIPA buffer to 100mm dish. Scale up or down as necessary
4. Scrape cells into RIPA buffer and transfer to small centrifuge tube
5. Stand on ice for 10min, vortexing every few minutes to dissolve material. Lysates can also be passed through a 22 gauge needle to aid in solubilisation
6. Centrifuge at 17,000rpm for 10min
7. Remove supernatant for protein assays and discard the pellet

NOTE: For experiments in which it is not desirable to fully denature proteins and possibly break protein:protein interactions, the RIPA buffer can be replaced with a non-denaturing NP40 Solubilisation Buffer. Recipe: 150mM NaCl 20mM Tris, pH 7.5, 1% NP40 or 1% Triton-X-100, and 5mM EDTA. If this non-denaturing buffer is used, lysates should be homogenised or passed through a needle several times to ensure adequate solubilisation.

Q. How can I reduce background bands in my Western blot?

A. Optimise the concentration of primary and secondary antibodies. In some cases, increasing the concentration of blocking agent (BSA or non-fat dry milk) reduces background signal. After incubation with the primary antibody, wash at least two times with TBST (include 0.5M NaCl in one or more of the wash steps). Avoid Nonidet™ P40 or Triton™ X-100 in buffers as these detergents decrease because protein detection.

Q. Can I use BSA (Fisher Bioreagent Cat. No 12737119) to make blocking buffer for Western blotting?

A. Yes, Cat. No 12737119 (Bovine Serum Albumin, fraction V heat shock treated), can be used in a number of molecular biology applications including Western blots (as a blocking agent) and ELISA and as a stabiliser for enzymatic reactions. Another newer BSA product that you may consider is Cat. No 12871630 (BSA, Heat Shock Treated and Protease Free). This product has found great use in RIA and ELISA and as a blocking agent.

Q. How can I store, strip, and reuse my Western blot?

A. For storage, following transfer, air dry the blot and place it between two clean sheets of filter paper. Place the blot-filter paper sandwich between two sheets of card, in order to keep it flat, and place it in a sealable plastic bag. The blot can be stored at 4°C for up to two weeks, -20°C for up to two months or indefinitely at -80°C. When ready to reprobe, pre-wet the blot with alcohol for a few seconds, followed by a few rinses with pure water to reduce the alcohol concentration.

To strip the blot:

- In a fume hood submerge the blot in stripping buffer (100mM β-mercaptoethanol, 2% SDS, 62.5mM Tris-HCl, pH 6.7) and incubate at 50°C for 30min with occasional agitation
- Wash 2 x 10min in TBS-T/PBS-T at room temperature
- Block the membrane by immersing in 5% blocking reagent TBS-T or PBS-T for 1hr at room temperature
- Proceed with next round of immunodetection

Often you do not need such harsh conditions to remove antibodies from their proteins. An alternative and milder method for stripping a blot is achieved by lowering the pH of the stripping buffer.

- Submerge the blot in stripping buffer (1% SDS, 25mM glycine-HCl, pH 2.0) and incubate at 50°C for 30min with occasional agitation
- Wash 2 x 10min in TBS-T/PBS-T at room temperature
- Block the membrane by immersing in 5% blocking reagent TBS-T or PBS-T for 1hr at room temperature
- Proceed with next round of immunodetection

References

1. Sambrook, Fritsch, and Maniatis, *Molecular Cloning, A Laboratory Manual, Second Edition*, Cold Spring Harbor Laboratory Press, 1989
2. *Current Protocols in Molecular Biology*, Greene Publishing Associates and Wiley-Interscience, 1989
3. Weiss, W., Weiland, F. & Görg, A. (2009), Protein detection and quantitation technologies for gel-based proteome analysis, in J. Reinders & A. Sickmann, eds, 'Proteomics', Vol. 564 of *Methods in Molecular Biology*, Humana Press, pp. 59–82.

DISCLAIMER: Please note that whilst Fisher Scientific makes every effort to ensure that information provided to customers is accurate, all information or suggestions offered by Fisher Scientific are based upon the information provided by customers and is intended to be general in nature only. Fisher Scientific cannot guarantee that any information or suggestions are suitable for the particular needs or requirements of customers, and customers are encouraged to conduct their own assessment of any information or suggestions given.

POWER SUPPLIES IN ELECTROPHORESIS

Electrophoretic techniques all rely on the application of an electric field and so selection of an appropriate power supply for your requirements is essential

Mnemonic trick
PAN(I)C – **P**ositive **A**node **N**egative (**I**ons) **C**athode



In general, whether you use constant or variable voltage power sources, the higher the voltage is applied, the faster the samples migrate. However, the maximum amount of voltage that can be applied depends upon the design of the electrophoresis apparatus and should not exceed manufacturer's recommendations. For example, voltage that is too high can melt the agarose gel during electrophoresis and cause distortion of results.

The choice of power supply can vary depending on the application it is being used for. For example, Isoelectric Focusing (IEF), the electrophoretic technique for the separation of proteins based on their isoelectric points (pI), requires a high current (up to 3,000mA) whereas migration of DNA in a mini gel unit will require less than 400mA.

The following table will help to guide you select the right power supply for your particular application.

Power Supplies Selection Guide

APPLICATION	MINI 300V PLUS	MINI 300V/4	POWER SUPPLY 300	POWER SUPPLY 350	POWER SUPPLY 608	POWER SUPPLY 3000	POWER SUPPLY 9003 P
Horizontal Gel Electrophoresis							
Wide Format, Mini-Plus	•	•	•				
Wide Format, Midi-Plus		•	•	•	•		
SUB-GEL Mini	•	•	•				
SUB-GEL Midi		•	•	•	•		
SUB-GEL Midi Plus				•	•		
SUB-GEL Maxi				•	•		
IEF						•	•
Vertical Gel Electrophoresis							
Verti-Gel Mini, 2-Gel System (Standard)	•	•	•				
Verti-Gel Mini, 4-Gel System (Tetrad)	•	•	•				
Verti-Gel Maxi, 2-Gel System (Standard)				•	•		
DNA Sequencing						•	•
Blotting							
Semi Dry Blotter, Maxi					•	•	•
Western Blotting		•	•		•	•	

Mini 300V Plus and Midi 300V/4

These models benefit from a small footprint area and compact design, while explanatory user-friendly menus facilitate easy set up. These power supplies adhere to IEC 61019 - one of the world's most stringent electrical safety standards.

Mini 300V Plus

The new Mini 300V Plus offers great performance at an affordable price. With maximum constant current output of 400mA and constant voltage up to 300V, the Mini 300V Plus is capable of running all Fisher Scientific horizontal SUB-GEL systems and vertical Verti-Gel PAGE mini gel systems, either on a continuous run or on a timed setting up to 999 minutes. The Mini 300V user friendly interface with a clear LED display is easily adjustable in 1V and 1mA increments making it perfect for separations where precise settings are required. It has an ultra compact footprint and two pairs of parallel power terminals allow electrophoresis units to be run simultaneously.

- Enhanced in-built safety features
- 3-digit LED display
- Individual indication of control parameter
- Alarm function
- New wipe clean polycarbonate housing

Output Specifications

Voltage, V	10 to 300
Current, mA	10 to 400
Power [max.], W	60



Cat. No	Description	Dimensions, mm
12643546	Mini 300V Plus Power Supply, 300V, 400mA, 600W, 100-240V a.c., twin output	140 x 191 x 84

Midi 300V/4

With nearly twice the current and power of an alternative market leading product, at 700mA and 150W, the Midi 300V/4 offers a specification comparable to any equivalent power supply presently available on the market. The Midi 300V/4 is suitable for use with all Fisherbrand horizontal SUB-GEL systems and Verti-Gel units. Microprocessor controlled, with four sets of power terminals that allow simultaneous operation of up to four electrophoresis units either at constant voltage or constant current. The timer function may be set to run continuously or up to a maximum 999 minutes with an alarm that sounds to signify termination of the run. A user friendly keypad houses a clear 3-digit LED to aid set up, as well as a convenient 'pause/resume' key, particularly useful during extended runs when it is necessary to access the gel tank to monitor buffer levels and sample migration.

- Stackable design
- In-built safety systems
- Automatic crossover between parameters
- Individual indication of control parameter
- Dual voltage compatibility

Output Specifications

Voltage, V	2 to 300
Current, mA	1 to 700
Power [max.], W	150



Cat. No	Description	Dimensions, mm
12613546	Midi 300V/4 Power Supply, 300V, 700mA, 150W, 100-240V a.c., four output	190 x 305 x 95

Power supply models 300, 350, 608, 3000

These models are equipped with many user friendly design features which allow quick and simple operation. Powerful, easy to use and robust, the Fisherbrand range below covers all your application needs.

Power supply 300

Permits electrophoresis with constant mode whilst limiting the other selected values. Two operating modes with auto crossover. Two LEDs indicate the constant parameters. Last setting is restored at power up. Unit has two safety outlets.



Power supply 350

Features are the same as the Power Supply 300, with the addition of Gel Saver and Gel Timer. Gel Saver maintains gel, preventing band diffusion when the run is complete.



Power supply 608

Permits electrophoresis with constant mode whilst limiting the other selected values. Two operating modes with auto crossover. Unit has three safety outlets and is fitted with a circuit breaker. Auto restart in case of power failure. Programmed by tactile switches.



Power supply 3000

Recommended for nucleic acid sequencing and agarose electrophoresis. Three operating modes with auto crossover. Permits electrophoresis with constant mode whilst limiting the other selected values. Unit has three safety outlets. Fitted with a circuit breaker. Last setting is automatically restored at power up. Auto restart in case of power failure. Programmed by tactile switches.



Technical Specification - General

Constant voltage [Y/ N]	Y
Constant current [Y/ N]	Y
Operating temperature, °C	0 to 40
Electrical supply	230V, 50/60Hz

Technical Specification - Specific

Cat. No	11566903	11536873	11596863	12335167
Model No	300	350	608	3000
Output	300V, 400mA, 100W	300V, 500mA, 100W	600V, 800mA, 300W	3,000V, 300mA, 300W
Constant power [Y/N]	N	N	N	Y
Timer	N	Y	Y	N
Alarm	N	N	Y	Y
Resolution	10V to 300V/1V 15µA to 400mA	1V to 300V/1V 1V to 500µA	10V to 600V/1V 15µA to 800mA	10V to 3,000V/10V 15µA to 300mA
Power, W	100	100	300	300
Regulated power, V	1	1	5	10
Regulated current, W	1mA	1mA	1mA	1mA
Fault detection	Stop	Stop	Auto stop and audible alarm	Stop and audible alarm
Dimensions [w x d x h], mm	170 x 240 x 70	170 x 240 x 70	270 x 340 x 100	270 x 340 x 110
Mass, kg	1.6	1.8	4	4

Cat. No	Description
11566903	Power supply 300
11536873	Power supply 350
11596863	Power supply 608
12335167	Power supply 3000

Power supply model 9003 P

Suitable for all high voltage applications and those requiring V/hr integration, including nucleic acid sequencing and Isoelectric Focusing (IEF).

- Stackable design
- Inbuilt safety systems
- Automatic crossover between parameters
- Individual indication of control parameter
- Dual voltage compatibility



Memory store: 16 'one step' programs with automatic cut off; eight sequenced programs with up to 10 steps which automatically follow preset values for each step; one specific program for low current -15µA (IEF).

LCD display: two lines of 20 characters.

Twenty switch keyboard: for monitoring each function.

Four operating modes: Constant voltage, constant current, constant power or temperature limitation. Automatic crossover from one mode to another occurs when output limits are reached. Flashing display indicates the constant mode.

Automatic restart: In case of power failure during a cycle. When the power returns, an audible safety alarm rings for 10 seconds, and then the START mode turns on automatically at the preset values.

Parameter storage: Automatic storage of the preset and elapsed values (minutes and V/hr) in case of power failure or voluntary interruption during the cycle.

Safety: This microprocessor controlled power supply is equipped with a circuit breaker which automatically cuts the electrical supply in case of ground leakage detection, (500µA) short circuit, open circuit or overload. Specific messages are displayed.

Output sockets: 1 x 2mm output, 1 x 4mm output. No need for adapters to use different equipment connectors.

Temperature control: The power supply is designed for automatic temperature regulation as well as voltage, current and power. The optional temperature probe maintains constant temperature during electrophoresis by reducing or stopping the voltage and current output when the set temperature is surpassed. Once the temperature drops below the set point, both voltage and current output is resumed at the set levels. The use of the temperature regulation mode prevents the activation of the power (Watt) regulation mode. The display (Min R) is a dedicated timer for increments of minutes while the power supply is monitored by the temperature function. This timer increments minutes only when voltage and current are turned off during the temperature regulation mode. The main timer (Min T) remains operational at all times during the operation of the power supply and provides the automatic termination of the voltage and current output.

Technical Specification

Output.....	10V to 3,000V, 10V (10V steps)
.....	1mA to 300mA (1mA steps)
.....	15µA to 300mA (low current IEF)
.....	0.3W to 300W (1W steps)
Temperature range, °C.....	0 to 99 (1°C steps)
Timer range, min.....	1 to 9,999 (1min steps)
Integrator range.....	1 to 99,999V/hr (1V/hr steps)
Values.....	Minimum regulated values
.....	10V/1mA/1W
.....	Minimum non-regulated values
.....	10V/15µA/0.3W
Display parameter.....	Value display range/resolution
.....	0 to 3,000V (10V)
.....	0 to 300mA (1mA)
.....	0 to 300W (1W)
.....	0 to 99°C (1°C)
.....	0 to 99,999V/Hr (1V/Hr steps)
.....	0 to 9,999min (1 min steps)
Fault detection.....	Stop, audible alarm and display message
Dimensions [w x d x h], mm.....	270 x 340 x 110
Mass, kg.....	4

Cat. No	Description
12374058	Power 9003 P
10384651	Optional temperature probe

TECHNICAL RESOURCES



TechSupport

Here to give you a helping hand!

Fisher Scientific's Product Support Team is your dedicated resource. Our Product Support Advisors are all highly qualified professionals who are here to support and guide you to the fastest, most effective and efficient answer to your enquiry.

Areas of technical expertise include:

- Bioreagents and Life Science
- Chemicals and Chromatography
- Consumables
- Equipment
- Safety

This section features a helpful troubleshooting guide and FAQ's. If, however, this information does not resolve the issue, or if you have questions not covered below

Contact our Product Support Advisors
Tel: 01509 555888
Email: fisheruk.productsupport@thermofisher.com

Power Supplies Troubleshooting Guide

The following table lists some of the most commonly experienced problems with vertical gel units along with useful suggestions for solving them.



Problem	Cause	Solution
No Display / lights	No a.c. power	<ul style="list-style-type: none"> • Check if the power supply is unplugged, or if the a.c. power source is a problem
	a.c. power cord is not connected	<ul style="list-style-type: none"> • Check a.c. power cable to ensure that it is compatible with the power supply • Use the correct power cable
	The fuse has blown	<ul style="list-style-type: none"> • Replace the fuse
Fuse repeatedly broken	Hardware failure	<ul style="list-style-type: none"> • Contact Fisher Scientific's Customer Service department
Operation stops	Electrophoresis cables are not connected to the power supply or to the electrophoresis unit(s). There is a broken circuit in the electrophoresis tank	<ul style="list-style-type: none"> • Check the connections to the power supply and the electrophoresis tank to ensure they are intact; check the condition of wires in the electrophoresis unit. Close the circuit by reconnecting the cables • Press START/STOP to resume the run
	High resistance due to tape left on a pre-cast gel; an incorrect buffer concentration or volume in the electrophoresis tank	<ul style="list-style-type: none"> • Ensure that any tape is removed from the ends of a pre-cast gel, the buffers are prepared correctly, and the recommended volume of buffer is added to the electrophoresis tank
Er1 Error message	Current exceeds the maximum output for the power supply (>400mA)	<ul style="list-style-type: none"> • Check if the buffer concentration or molarity is appropriate (Excessive buffer concentration or molarity may increase conductivity) • To clear the error message, press the START/STOP button
Er2 Error message	Voltage exceeds the maximum output for the power supply (>300V)	<ul style="list-style-type: none"> • Press the START/STOP button to clear the error message. • Contact Fisher Scientific's Customer Service department if the problem persists
Er3 Error message	Thermal limitation of the power supply reached (Output voltage <10V)	<ul style="list-style-type: none"> • Check the connections • If the Er3 error message persists, the problem may be caused by internal (2) fan failure. • Contact the Fisher Scientific's Customer Service department
nld Message	No load is detected	<ul style="list-style-type: none"> • Check the connections • Check the buffer condition/ buffer level
AL1 Alarm message	Power exceeds the maximum output (60W)	<ul style="list-style-type: none"> • Warning message for reference

Frequently asked questions (FAQ's) – Power Supplies

This section lists the most frequently asked questions received by our Life Science and Chemical Specialists, together with the answers they provided (also refer to pages 22 to 23 and 43 to 45). If you are unable to find the answer to your question, are stuck and need help or are simply confused and unsure of which product best suits your research needs, the Product Support Team are here and ready to respond to your enquiries.

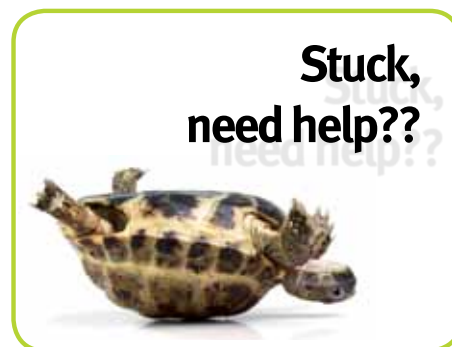

Contact our Product Support Advisors

Tel: 01509 555888

Email: fisheruk.productsupport@thermofisher.com

Q. What are the relations between Voltage, Current, Power and Resistance?

A. Power (W) = Voltage (V) x Current (A)

Resistance (Ω) = Voltage (V) / Current (A)

Q. How important is the resistance of an electrophoresis unit?

A. The resistance of an electrophoresis unit depends on its size, gel thickness, amount of buffer, buffer conductivity and temperature. This resistance will normally decrease in time due to a slowly increasing temperature. Electrophoresis units which have a resistance below the minimum load resistance of a power supply will trigger an alarm! Read the output voltage and current during a run to measure the resistance and use above formula to calculate the value.

Q. Why are my output values different from those of a similar experiment?

A. Either your programmed parameters are not equal to those described or the resistance of your electrophoresis unit is different (see above). It cannot be due to e.g. another model of power supply as the relations between Voltage, Current, Power and Resistance are monitored in the same way by any instrument.

Q. What about connecting more than one unit to the same power supply?

A. If outlets are in parallel each electrophoresis unit will be supplied with exactly the same voltage. However, current and power may differ due to differences between them even when exactly the same model, gel, buffers, etc. are used. Therefore, it is recommended to run several electrophoresis units only in the constant voltage mode on the same power supply.

Q. What about the influence of temperature?

A. Electrophoresis at high voltages produces heat. Additionally, high conductivity buffers such as TAE generate more heat than low conductivity buffers. Care should be taken in agarose gel electrophoresis with voltages greater than 175V, as heat build up can generate gel artifacts such as S-shaped migration fronts, and in extended electrophoresis runs, can even melt the agarose gel. With high voltage electrophoresis, the use of low melting point agarose gels should be avoided.

DISCLAIMER: Please note that whilst Fisher Scientific makes every effort to ensure that information provided to customers is accurate, all information or suggestions offered by Fisher Scientific are based upon the information provided by customers and is intended to be general in nature only. Fisher Scientific cannot guarantee that any information or suggestions are suitable for the particular needs or requirements of customers, and customers are encouraged to conduct their own assessment of any information or suggestions given.

This section features key Fisherbrand consumables and apparatus to supplement your electrophoresis needs. Once again Fisherbrand demonstrates that it's going that extra mile to continually deliver you quality, affordable products.



CENTRIFUGATION



Mini centrifuge

- Speed, rpm: max. 6,000
- UV resistant plastic
- Dimensions (w x d x h), mm: 153 x 128 x 104
- Includes two interchangeable rotors, six place standard rotor and an eight place strip rotor

Cat. No	Description
13406188	Mini centrifuge



Midi centrifuge

- Speed, rpm: 500 to 12,500
- Dimensions (w x d x h), mm: 203 x 171 x 114
- Tool-free quick change rotor system

- Supplied with two rotors:
- Twelve place standard rotor with lid for 1.5/2.0mL tubes
 - Eight place strip rotor for four 0.2mL tube strips or 32 single tubes
 - Twelve 0.2mL & 0.5mL adapters for customised use

Cat. No	Description
12972041	Midi centrifuge

Microtubes, non-sterile, graduated



Cat. No	Description	Capacity, mL	Colour	Height, mm	Diameter, mm	Maximal speed, xg	Pack qty
11916955	Standard	0.6	Natural	30	8	30,000	500
11926955	Standard	1.5	Natural	40	11	26,000	500
11936955	Standard	2.0	Natural	40	11	25,000	500
11323653	Low binding	0.6	Natural	30	10	30,000	500
11986955	Low binding	1.5	Natural	40	13	-	250
11333653	Low binding	2.0	Natural	40	13	-	250
11393643	Safelock	0.6	Natural	-	-	30,000	1,000
11706467	Safelock	1.5	Natural	-	-	26,000	500
11323633	Safelock	1.5	Mixed	-	-	26,000	500
11313633	Safelock	2.0	Natural	-	-	25,000	500

Centrifuge tubes 15mL and 50mL

- A large white marking area makes it easy to label samples
- Tubes are sterilised by gamma radiation and are non-cytotoxic

Centrifuge tubes 15mL

- Polypropylene
- Available with a blue plug seal closure with a double-start thread design that provides a tight secure seal
- Graduated in 0.5mL subdivisions from 2mL to 14.5mL, 17mm x 119mm
- Packed in racks

Cat. No	Closure style	RCF, x g [max.]	Inner pack qty	Pack qty
11849650	Flat top	12,000	50	500
11755075	Flat top	3,600	-	500
11765075	Plug seal	3,600	-	500

- Polyethylene terephthalate (PET)
- Packed in racks

Cat. No	Closure style	RCF, x g [max.]	Inner pack qty	Pack qty
11879640	Plug seal	1,800	50	500



Centrifuge tubes 50mL

- Polypropylene
- Graduated in 5mL subdivisions from 5mL to 50mL, 28mm x 115mm
- All are sterile except 11829650

Cat. No	Closure style	RCF, x g [max.]	Pack type	Inner pack qty	Pack qty
11819650	Flat top	6,000	Rack	25	500
11899640	Plug seal	6,000	Rack	25	500
11809650	Plug seal	6,000	Sleeve	25	500
11829650	Plug seal	6,000	Sleeve	25	500

- Polyethylene terephthalate (PET)
- Plug seal

Cat. No	RCF, x g [max.]	Pack type	Inner pack qty	Pack qty
11839650	1,800	Rack	25	500



Microcentrifuge tube racks

Four way tube rack

- Each rack can hold 4 x 50mL conical tubes, 12 x 15mL conical tubes, 32 x 1.5mL microtubes or 32 x 0.5mL microtubes
- Rack measures 174mm x 95mm x 52mm
- Autoclavable

Cat. No	Description	Pack qty
11700055	Four way tube rack, assorted colours (blue, green, pink, yellow and orange)	5



Rota-Rack™

- Each module of the small Rota-Rack™ holds 6 x 15mL tubes, 9 x 1.5/2mL tubes, 12 x 0.5/0.6mL tubes or 32 independent 0.2mL PCR* tubes or 4 x 8 tube strips
- Each rack has modules in green, pink, blue and yellow, and is fully autoclavable

Cat. No	Description	Pack qty
11394085	Rota-Rack™, for micro tubes	1



CHROMATOGRAPHY



Vials, crimp top, 11 mm (wide opening)

Cat. No	Description	Capacity, mL	Dimensions, mm	Pack qty
Clear glass				
11585874	Crimp vial, wide opening, 1st hydrolytic class	1.5	11.6 x 32	100
Amber glass				
11545884	Amber glass, wide opening, graduated with marking spot	1.5	11.6 x 32	100



Caps, crimp, aluminium, 11 mm

Cat. No	Description	Thickness, mm	Pack qty
11561494	With red-orange natural rubber/transparent TEF seal (Agilent quality)	1.0	100
11595864	With red rubber/PTFE seal (Agilent quality)	1.0	100

A full range of reagents, solvents and buffers for chromatography are available in the Fisher Chemical product range and can be found in the Laboratory Reagents Handbook (refer to page 3)

CRYOGENICS

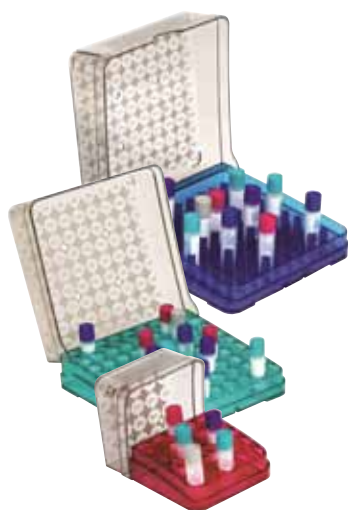

Cryoboxes, polycarbonate, Arctic Squares™

- Boxes will safely store vials from -196°C to +121°C
- The forward sloped base, high contrast and printed indexing on the transparent lid enable quick visual identification
- All boxes have vent and draining holes
- Autoclavable at 121°C

Cat. No	Description	Dimensions, L x D x H, mm	Colour	Pack qty
11394055	9 x 9 array tall boxes for 3mL/5mL vials	133 x 133 x 96	Purple	5
11998004	9 x 9 array for 1.2mL/2mL, vials, includes picking tool	133 x 133 x 53	Assorted	4
11978004	10 x 10 array for 1.2mL/2mL, vials, includes picking tool	133 x 133 x 53	Blue	4
11988004	Microtube boxes including high temperature melamine foam insert (not recommended for use with liquid nitrogen) for use between -90°C and 90°C, store up to 64 microtubes. Inserts hold 0.5mL and 1.5mL tubes. Picking tool included.	133 x 133 x 53	Green	4

Cryogenic vials, polypropylene

- Sterile - non-autoclavable
- Non-cytotoxic; non-pyrogenic
- Large white writing area
- Graduations in 0.5mL increments



Cat. No	Description	Volume, mL	Pack qty
External thread, self standing			
12942431	Conical bottom	1.2	1,000
12952431	Conical bottom	2.0	1,000
12962431	Conical bottom	5.0	1,000
Internal thread, conical or round style bottom with a star style foot; self standing			
11311675	Conical bottom	1.2	1,000
11321675	Round bottom	2.0	1,000
11331675	Round bottom	5.0	1,000

GLASSWARE

Beakers, squat form

- Borosilicate glass
- Squat form with spout and graduations
- ISO 3819 DIN 12331

Cat. No	Capacity, mL	Height, mm	Exterior diameter, mm	Pack qty
11597392	25	50	34	10
11507402	50	60	42	10
11517402	100	70	50	10
11527402	150	80	60	10
12907600	250	95	70	10
11547402	400	110	80	10
11557402	600	125	90	10
11567402	800	135	100	10
11577402	1,000	143	105	1
11587402	2,000	185	130	1
11507412	5,000	270	170	1



Bottles

- Borosilicate glass, reagent and media, screw neck
- Graduated and supplied with blue polypropylene cap and pouring ring
- Chemically resistant
- Autoclavable

Cat. No	Capacity, mL	Height, mm	Exterior diameter, mm	Pack qty
12937630	10	105	56	10
11738151	250	143	70	10
11389493	500	181	86	10
11359493	1,000	230	101	10
11369493	2,000	267	136	1



Cylinders, borosilicate glass, Class A

- Graduated in blue ceramic markings
- Hexagonal base
- Individual reorder code on each item
- DIN 12680 BS 604 ISO 4788
- Pouring spout

Cat. No	Capacity, mL	Graduations, mL	Pack qty
11517832	10	0.2	2
11527832	25	0.5	2
11537832	50	1.0	2
11547832	100	1.0	2
11557832	250	2.0	2
11567832	500	5.0	2
11577832	1,000	10.0	2



Cylinders, borosilicate glass, Class B

- Graduated in blue ceramic markings
- Hexagonal base
- Individual reorder code on each item
- DIN 12680 BS 604 ISO 4788
- Pouring spout

Cat. No	Capacity, mL	Graduations, mL	Pack qty
11507702	5	0.1	2
11517702	10	0.2	2
11527702	25	0.5	2
11537702	50	1.0	2
11547702	100	1.0	2
11557702	250	2.0	2
11567702	500	5.0	2
11577702	1,000	10.0	2
11587702	2,000	20.0	1





Funnels, borosilicate glass, conical

Cat. No	Top diameter, mm	Pack qty
11572423	55	10
11582423	75	10
11592423	100	10
11502433	150	1
11512433	200	1



Funnels, borosilicate glass, conical, powder

Cat. No	Top diameter, mm	Stem length, mm	Stem O.D., mm	Pack qty
12983591	50	20	13	1
12993591	70	25	16	1
12903601	100	25	22	1

Funnels, soda lime glass, conical

Cat. No	Top diameter, mm	Stem length, mm	Pack qty
11502423	35	40	1
11512423	45	45	1
11522423	50	50	1
11532423	55	55	1
11542423	60	60	1
11552423	70	70	1
11562423	100	100	1



LIQUID HANDLING

Watch our SureOne™ filter tip reload system and Elite pipettors video to discover more

Elite Pipettors

- Soft-touch tip ejector
- Optimal fit to SureOne™ pipettor tips
- Fully autoclavable
- Comfortable, lightweight handle with finger rest
- Extremely low plunger forces



Single channel

Cat. No	Volume, µL
11815762	0.2 to 2
11825762	0.5 to 5
11835762	1 to 10
11845762	2 to 20
11855762	5 to 50
11865762	10 to 100
11875762	20 to 200
11885762	100 to 1,000

Multichannel

Cat. No	Volume, µL
11815772	1 to 10
11825772	2 to 20
11835772	5 to 50
11845772	10 to 100
11855772	20 to 200
11865772	100 to 1,000
11875772	500 to 5,000
11885772	1,000 to 10,000

Pipettor tips, filter, universal fit, SureOne™

- Sterile packaging with outer sleeve protects tips from exterior contamination

Cat. No	Volume, µL	Pack type	Colour	Inner Pack qty	Pack qty
10µL micropoint tip, graduated at 2µL					
11903466	0.1 to 10	Filtered sterile	Clear	96	960
11933416	0.1 to 10	Bulk	Clear	-	1,000
10µL extended length micropoint tip, graduated at 2.5µL					
11913466	0.1 to 10	Filtered sterile	Clear	96	960
11983416	0.1 to 10	Bulk	Clear	-	1,000
20µL universal bevelled tip					
11943466	2 to 20	Filtered sterile	Clear	96	960
100µL universal bevelled tip					
11953466	10 to 100	Filtered sterile	Clear	96	960
200µL universal bevelled tip					
10124314	1 to 200	Bulk	Yellow	-	1,000
200µL universal micropoint tip, graduated at 10µL, 50µL and 100µL					
11963466	20 to 200	Filtered sterile	Clear	96	960
1,000µL universal micropoint tip, graduated at 100µL, 200µL, 500µL and 1,000µL					
11973466	10 to 1,000	Filtered sterile	Clear	96	960
1,250µL universal micropoint tip, graduated at 100µL, 200µL, 500µL and 1,000µL					
10778535	100 to 1,250	Racked sterile	Clear	96	960
Micropoint tip Eppendorf style					
11903426	0.1 to 20	Bulk	Clear	-	1,000

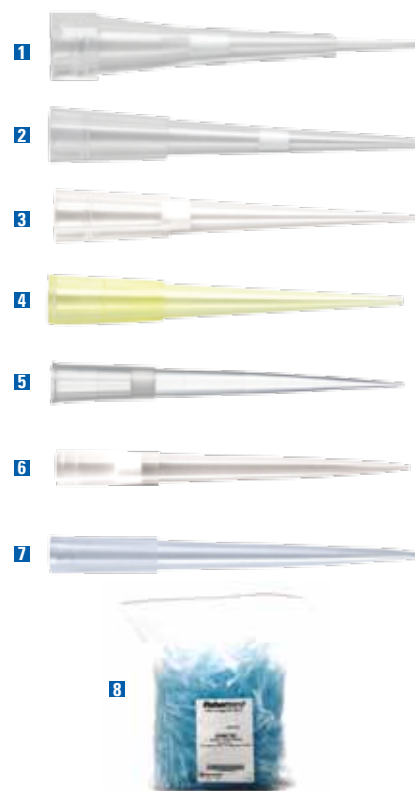

SureOne™ speciality tips

- Fisherbrand SureOne™ speciality pipettor tips include gel loading, genomic and extended length tips, in bulk, racked and sterile racked packaging
- SureOne™ universal fit, speciality pipettor tips are compatible with most popular brands of pipettor (optimal fit with Fisherbrand Elite™ pipettor)
- Non-sterile products - certified to be free of RNase/DNase and DNA
- Sterile products - e-beam sterile products are certified to be free of RNase/DNase, pyrogen, bioburden, PCR* inhibitors and endotoxins

Cat. No	Description	Volume, µL	Pack type	Filtered	Sterile	pack qty
11927734	Extra length	1 to 200	Bulk	No	No	1,000
11937734	Extra length	1 to 200	Racked	No	No	1,632
11367801	Extra length	1 to 200	Racked	No	Yes	1,632
11957734	Extra length	20 to 200	Racked	Yes	Yes	1,632
11967734	Geload	1 to 200	Bulk	No	No	1,000
11977734	Geload	1 to 200	Racked	No	No	960
11987734	Geload	1 to 200	Racked	No	Yes	960
11997734	Geload	2 to 20	Racked	Yes	Yes	1,020
11907744	Geload	10 to 100	Racked	Yes	Yes	1,020
11917744	Genomics	1 to 200	Bulk	No	No	1,000
11927744	Genomics	1 to 200	Racked	No	No	960
11937744	Genomics	1 to 200	Racked	No	Yes	960
11947744	Genomics	20 to 200	Racked	Yes	Yes	960
11957744	Genomics	100 to 1,000	Racked	No	No	960
11967744	Genomics	100 to 1,000	Racked	No	Yes	960
11977744	Genomics	100 to 1,000	Racked	Yes	Yes	1,000

*Polymerase Chain Reaction (PCR) is a process covered by patents owned by Hoffmann-La Roche

NEW



Pipettor stand

Cat.No.	Description
11895772	Pipettor stand, Elite, accommodates six pipettors

Reagent reservoirs

Cat. No	Capacity, mL	Material	Sterile	Pack qty
11908495	50	PVC	No	100
11988485	50	PS	Yes	80
11978485	50	PS	Yes	200
11998485	100	PS	Yes	200



NEW

Transfer pipettes

- Low density polyethylene
- Transparent
- Graduated or non-graduated
- Sterile options available
- Various packaging formats



	Cat. No	Description	Sterile	Length, mm	Drop volume, μL	Drop per mL	Pack qty
1	13469118	Transfer pipette PE, 1mL	No	104	33	30	400
2	13499108	Transfer pipette PE, 1mL, graduated	No	150	33	30	500
3	13439118	Transfer pipette PE, 1mL, graduated, extended tip	No	150	33	30	500
	13489108	Transfer pipette PE, 1mL, graduated	Yes	150	33	30	500
	13419118	Transfer pipette PE, 1mL, graduated, inner pack of 10	Yes	150	33	30	500
	13429118	Transfer pipette PE, 1mL, graduated, inner pack of 20	Yes	150	33	30	500
4	13439108	Transfer pipette PE, 3mL, graduated	No	155	40	25	500
	13469108	Transfer pipette PE, 3mL, graduated	Yes	155	40	25	500
	13479108	Transfer pipette PE, 3mL, graduated, inner pack of 10	Yes	155	40	25	500
	13409118	Transfer pipette PE, 3mL, graduated, inner pack of 20	Yes	155	40	25	500
5	13459118	Transfer pipette PE, 4mL, thin stem	No	150	33	30	500
6	13459108	Transfer pipette PE, 4mL	No	150	33	50	500
7	13449108	Transfer pipette PE, 7mL, extra long	No	300	50	20	100
8	13449118	Transfer pipette PE, 10mL, jumbo	No	170	56	18	200

MICROPLATES

Microplates, polypropylene, 96 and 384 well

- Resistant to most reagents
- Withstand temperatures from -80°C to 121°C making these plates ideal for storage
- Round bottom wells for optimal sample recovery
- Come in a variety of colours for quick identification of storage plates



Cat. No	Product	N° of wells	Well bottom	Well volume	Colour	Sterile	Pack qty
11907954	Plate	96	Round	500 μl	Natural	N	80
13505450	Plate	96	Round	500 μl	Natural	Y	120
11917954	Plate	96	Round	500 μl	Red	N	80
11927954	Plate	96	Round	500 μl	Yellow	N	80
11937954	Plate	96	Round	500 μl	Blue	N	80
11381555	Deepwell	96	Round	1ml	Natural	N	50
13515450	Deepwell	96	Round	1ml	Natural	Y	50
13535450	Deepwell	96	Round	2ml	Natural	N	60
13545450	Deepwell	96	Round	2ml	Natural	Y	60
13555450	Deepwell	384	Flat	250 μl	Natural	N	60
13565450	Plate	384	Conical	35 μl	Natural	N	100
13575450	Plate	384	Conical	35 μl	Natural	Y	100
13595450	Plate	384	Conical	35 μl	Black	N	100
13585450	Plate	384	Conical	35 μl	White	N	100
11957954	Plate	384	Round	120 μl	Natural	N	120
11967954	Plate	384	Round	120 μl	Red	N	120
11977954	Plate	384	Round	120 μl	Yellow	N	120
11987954	Plate	384	Round	120 μl	Blue	N	120

MIXING

Homogenisers

- Powerful, versatile, and affordable
- Hand-held or bench top operation
- Ideal for use with a wide range of hard or soft samples
- Wide range of accessories

Cat. No	Description
15173007	Model 125, 0 to 25,000rpm
15193007	Model 125 PCR* kit, 0 to 25,000rpm
15183007	Model 500, 11,000 to 30,000rpm
15103017	Model 1000, 3,500 to 30,000rpm

Homogeniser accessories

Cat. No	Description
15113017	Base stand for model 125
15123017	Base stand for model 500 & 1000
15133017	Generator 0.1mL to 5mL working volume
15143017	Generator 0.3mL to 10mL working volume
15153017	Generator 0.3 to 10mL disposable (req. adapter), pack of 25
15163017	Generator 0.3 to 10mL disposable (req. adapter), pack of 50
15173017	Generator 5mL to 250mL working volume
15183017	Generator 50mL to 2,000mL
15193017	Generator 300mL to 7,000mL
15103027	Generator 500mL to 10,000mL
15113027	Adapter for disposable generators

NEW



Watch our homogeniser video to discover more



Stirrers, magnetic, unheated, mini

- Powerful enough to stir 1L of liquid at up to 2,000rpm
- Manufactured from a tough polypropylene with a clear, chemically resistant polycarbonate top
- With instructions, stir bar and power adapter

Technical Specification

Vessel capacity, L	1 (max)
Vessel diameter, mm	85 (max)
Speed range, rpm	350 to 2,000
Dimensions [w x d x h], mm	143 x 66 x 143
Mass, g	400
Electrical supply	230V, 50Hz

Cat. No	Description
11577493	Basic mini stirrer Fisherbrand
11587493	Digital mini stirrer Fisherbrand
11597493	Basic mini stirrer, Caffeine
11507503	Basic mini stirrer, Alchemist
11517503	Basic mini stirrer, DNA
11527503	Basic mini stirrer, Periodic Table
11537503	Basic mini stirrer, White Crystal



Magnetic followers, set, PTFE, cylindrical

- Set of 18 cylindrical followers in a compartmented box, comprising two each of the following sizes: 10mm x 6mm, 15mm x 4.5mm, 20mm x 6mm, 25mm x 6mm, 30mm x 6mm, 40mm x 8mm, 60mm x 10mm, 70mm x 10mm

Cat. No	Description
10226853	Magnetic followers



Magnetic follower restrainer

- Retrieve magnetic stirring bars easily from vessels with the handheld Spinbar™ restrainer

Cat. No	Description
11532912	Magnetic follower restrainer



*Polymerase Chain Reaction (PCR) is a process covered by patents owned by Hoffmann-La Roche

Mixer, rotator

A rotator with the option to add accessory heads for mixing micro-tubes, tubes and flasks. Heads are quick and easy to change.

- Suitable for continuous mixing, at variable speeds
- A small footprint rotator for general use
- Angle of the mixing disc is fully adjustable from horizontal to vertical
- Unit is benchtop or wall mountable

The three-layered mixing disc assembly is supplied ready for tube mixing. With the perforated mixing disc it is possible to 'mix and match' a variety of flask clips to suit different applications. Clips are supplied with all necessary fixings to enable them to be attached to the mixing disc.

Technical Specification

Speed range, rpm.....	5 to 30
Dimensions [w x d x h], mm	200 x 250 x 175
Mass, kg	3
Electrical supply	230V, 50/60Hz

Cat. No	Description
11796587	Mixer rotator

Cat. No	Description
Accessories	
12377488	24 clip disc for tube diameter 8mm to 11mm
12387488	12 clip disc for tube diameter 15mm to 17mm
12397488	6 clip disc for tube diameter 27mm to 30mm
11706597	Carousel for 16mm tubes
12317498	Carousel for 25mm tubes
Flask clips	
11756577	Flask clip, 100mL to 11mm
11766577	Flask clip, 250mL to 17mm

Mixer, vortex, Whirlimixer™ +plus

For tube, microplate, flask and microtube mixing using accessory platforms which are quickly interchangeable.

- Variable speed control giving controlled mixing over a speed range
- Where accessory platforms are fitted the unit can operate at lower speeds for gentle mixing reducing damage to cell structures
- Two modes of operation, 'set' for continuous running or 'press-start' suitable for use with accessory tube mixing cup
- Accessory platforms are autoclavable

Technical Specification

Speed range, rpm.....	200 to 2,800
Orbit diameter, mm	5
Dimensions [w x d x h], mm.....	150 x 175 x 150
Mass, kg	3
Electrical supply	230V, 50/60Hz, 75W

Cat. No	Description
10181211	Mixer, vortex, Whirlimixer +plus

Cat. No	Description
Accessories	
12367408	Platform for 2 x 25mL flasks
10164243	Platform for microtitre plate
10534404	Platform for 1.5mL microtubes
10489193	Cup for mixing up to 25mm dia. tubes
10296713	Platform for PCR* plate

*Polymerase Chain Reaction (PCR) is a process covered by patents owned by Hoffmann-La Roche



Vortex mixers

- Wizard model features unique infrared tube sensing system
- Protection: IP42
- Speed, rpm: 0 to 3,000
- Orbit diameter, mm: 4.5
- Dimensions [w x d x h], mm: 180 x 220 x 70
- Mass, kg: 2.4
- Electrical supply: 230V, 50Hz



Cat. No	Description
11726744	Vortex mixer, Classic
11746744	Vortex mixer, Wizard

pH & ELECTROCHEMISTRY

pH meters, AB series

- Multiple views
- Backlight display
- Date/time for GLP requirements
- Customer buffer calibration options
- Three position electrode holder
- Stirring capability
- Upgradeable software
- Wall mounting available



Watch our accumet™ pH meter video to discover more



Cat. No	Description
12840633	AB150 Meter - Includes meter, electrode arm, RS232 & USB cables, 100/240V power supply, and manual
12870633	AB150 Kit - Includes meter, TRIS compatible pH/ATC electrode, electrode arm, RS232 & USB cables, 100/240V power supply, and manual
12880633	AB150 BioBasic Kit - Includes meter, TRIS compatible accuTupH pH electrode, ATC probe, electrode arm, 110/220V power supply, and manual
12810643	AB200 Kit - Includes meter, TRIS compatible pH/ATC electrode, Conductivity/Temp probe, electrode arm, RS232 & USB cables, 100/240V power supply, and manual
12800643	AB200 Meter - Includes meter, electrode arm, RS232 & USB cables, 100/240V power supply, and manual

pH meters, XL series

- Colour touch screen
- Two stirring probe ports
- Three position electrode holder
- Upgradeable software
- USB & RS232 connectivity

Cat. No	Description
12820643	XL150 Kit - Includes meter, TRIS compatible accuTupH pH electrode, ATC probe, electrode arm, RS232 & USB cables, 110/220V power supply, and manual
12860643	XL250 Kit - Includes meter, TRIS compatible accuTupH pH electrode, ATC probe, electrode arm, RS232 & USB cables, 110/220V power supply, and manual
12840643	XL200 Kit - Includes meter, TRIS compatible accuTupH pH electrode, ATC probe, Conductivity/Temp probe, electrode arm, RS232 & USB cables, 100/240V power supply, and manual



pH accessories

pH electrodes



Cat. No	Description	Dimensions, mm
11706358	Electrode 1m cable with BNC epoxy body	12 x 120
11776348	Electrode 1m cable with DIN epoxy body	12 x 120
11749798	Electrode 1m cable with BNC glass body	12 x 120
11739798	Electrode 1m cable with DIN glass body	12 x 120
11786348	Electrode S7 head epoxy body	12 x 120
11786338	Electrode S7 head glass body	12 x 160
11769798	Electrode micro volume, 1m cable with BNC glass body	6 x 115
11709818	Electrode micro volume, 1m cable with DIN glass body	6 x 115
11755638	Electrode Tuff Tip, 1m cable with BNC epoxy body	12 x 120
11765638	Electrode Tuff Tip, 1m cable with DIN epoxy body	12 x 120
11775638	Electrode Tuff Tip, double junction 1m cable with BNC epoxy body	12 x 120
11785638	Electrode Tuff Tip, double junction 1m cable with DIN epoxy body	12 x 120
11736209	Electrode 6mm diameter. spear tip, S7 head glass body	12 x 90
11768452	ORP electrode 1m cable with BNC epoxy body	12 x 120
11778452	ORP electrode 1m cable with DIN epoxy body	12 x 120
11758452	ORP electrode S7 head epoxy body	12 x 120

Stirring probe, bench top

Cat. No	Description
12860653	Adjustable speed control compatible with AB and XL series

pH wash bottles

- Easy-fill polyethylene bottle, leakproof
- Precision acute angled dispensing jet
- Good chemical resistance

Cat. No	Description	Capacity	Pack qty
11532463	Wash bottle, narrow neck, general use, natural	250mL	6
11542463	Wash bottle, narrow neck, general use, natural	500mL	6

- LDPE bottle, wide neck, leakproof
- Labelled and colour coded for some of the most commonly used solvents

Cat. No	Description	Capacity	Pack qty
11507163	Wash bottle, vented, wide neck, DIY/custom, natural	500mL	3
11532473	Wash bottle, wide neck, deionised water, blue	500mL	6



pH buffers

- Colour coded buffer solutions
- Traceable to NIST and BS 1647 standard
- Stabilised with 10ppm mercuric chloride

Cat. No	Description	Quantity
10427260	Buffer solution pH 4 (phthalate)	1L
10477830	Buffer solution pH 7 (phosphate)	1L
10284240	Buffer solution pH 10 (borate)	1L



PLASTICWARE

Beakers, squat form, polypropylene, ultra clear

- Large pouring spout and moulded graduations
- Not suitable for stirrer hotplates

Cat. No	Capacity, mL	Pack qty
11572283	25	10
11512293	500	10



Beakers, squat form, PTFE

- Non-contaminating and inert to highly corrosive reagents
- Can be heated on a hotplate up to 280°C
- Spout for easy pouring
- Isostatically moulded from pure PTFE

Cat. No	Capacity, mL	Pack qty
10792921	100	1
10713101	250	1



Beakers, tri-cornered, polypropylene

- Suitable for use with commonly used acids, alkalis and solvents
- Each beaker has three drip-free pouring spouts
- Moulded graduations, stackable

Cat. No	Capacity, mL	Subdivisions, mL	Height, mm	O.D., mm	Pack qty
11759398	100	10	72	58	100
11769398	250	10	90	76	100
11799398	1,000	50	145	115	100



Bottles, amber, HDPE

Cat. No	Capacity, mL	Pack qty
12662415	60	12
12672415	125	12
12682415	250	12
12602425	500	12
12692415	1,000	6



Bottles, wide neck, HDPE

Cat. No	Capacity, mL	Pack qty
12961261	60	12
12981261	250	12
12991261	500	12





Bottles, wide neck, HDPE, bulk packs

- Bulk packaged for convenient liquid sampling, transport and storage
- Excellent chemical resistance to most acids, bases and alcohols
- Wide neck is easy to fill with solids or liquids
- Leakproof

Cat. No	Capacity, mL	Pack qty
11917974	125	500
11947964	250	250
11907964	500	125
11987924	1,000	50



Bottles, jerrycans, polyethylene, narrow neck

- Integrally moulded handle and tamper evident screw cap

Cat. No	Capacity, mL	Height, mm	O.D., neck, mm	Pack qty
11597433	1,000	165	38	1
11507443	2,500	205	45	1
11517443	5,000	282	38	1
11527443	10,000	314	61	1
11537443	25,000	470	61	1

Cuvettes, disposable

- Transparency: approximately 90% between 400nm and 800nm
- Range, nm: 336 to 850
- Lightpath, mm: 10
- Dimensions [w x h], mm: 12.5 x 45



1



2

Cat. No	Description	Capacity, mL	Material	Inner pack qty	Pack qty
1 11944385	Standard/macro	4.5	Polystyrene	100	500
11904385	Semi-micro	1.5	Methacrylate	100	500
11954395	4 clear sides	4.5	Polystyrene	100	500
11924405	4 clear sides	4.5	Methacrylate	100	500
2 11537692	Macro	4.0	Polystyrene	-	100
11547692	Semi-micro	1.6	Polystyrene	-	100

Cuvette, UV, single use

Cat. No	Description	Capacity, mL	Pack qty
10349334	Cuvette UV single use 4.0mL	4.0	100
10594175	Cuvette UV single use 1.6mL	1.6	100

Cylinders, graduated, with spout

- Large rounded bases ribbed for reinforcement and stability
- Calibrated 'To Contain/To Deliver' at 20°C - meets ASTM laboratory standards
- Chemical, heat and impact resistant makes these cylinders excellent for long term use
- No meniscus to confuse readings - eliminates guesswork

Cat. No	Capacity, mL	Pack qty
Cylinder PPCO		
11947884	10	12
11957884	25	12
11967884	50	12
11997874	100	8
11907884	250	8
11967874	500	6
11937874	1,000	4
11927874	2,000	2
Cylinder PMP		
11907894	25	18
11917894	50	18
11977884	100	12
11917884	500	8
11977874	1,000	6
11947874	2,000	4



Scoops, polypropylene

Cat. No	Capacity, mL	Length, overall, mm	Pack qty
11597852	250	260	1
11507862	500	315	1
11517862	1,000	385	1



SAFETY

Gloves, latex, disposable, contains Aloe vera

- Non-sterile
- Without skin irritation
- Colour: natural
- Thickness: 0.11 to 0.15mm
- Length: 240mm

Cat. No	Size	Pack qty
11854873	S	100
11864873	M	100
11874873	L	100
11884873	XL	100



Gloves, nitrile, disposable, contains Aloe vera

- Non-sterile
- Powder free
- Without skin irritation
- Colour: green
- Thickness: 0.10mm
- Length: 240mm

Cat. No	Size	Pack qty
11752779	S	100
11762779	M	100
11772779	L	100
11782779	XL	100



TEMPERATURE MAINTENANCE



Dry bath, Mini

- Compact, (d x l x h), mm: 120 x 140 x 60
- Stability at 37°C ±0.1°C
- Homogeneity: ±0.1°C to 37°C
- Timer: 0 to 19h:59min, or continuous

Cat. No	Description	Pack qty
12186560	Mini dry bath digital block heater, integral 12 x 1.5mL block, anodised aluminium, optional rack for rapid loading/unloading	1



Baths

- Capacity ranges from 2L to 28L
- Front mounted controls offer easier access and safer operation
- Compact footprint optimises laboratory bench space



Watch our Isotemp™ water bath video to discover more



Cat. No	Description	Pack qty
Analogue water bath		
10632153	Water bath, 2L, with acrylic cover	1
15157833	Water bath, 2L, shallow, with acrylic cover	1
10064544	Water bath, 5L, with acrylic cover	1
10106434	Water bath, 10L, with acrylic cover	1
15167833	Water bath, 5L/10L, dual chamber, with acrylic cover	1
15187833	Water bath, 20L, with acrylic cover	1
15177833	Water bath, 28L, with acrylic cover	1
Digital water bath		
15197833	Water bath, 2L, with acrylic cover	1
15117843	Water bath, 2L, shallow, with acrylic cover	1
15127843	Water bath, 5L, with acrylic cover	1
15137843	Water bath, 10L, with acrylic cover	1
15147843	Water bath, 5L/10L, dual chamber, with acrylic cover	1
15157843	Water bath, 20L, with acrylic cover	1
10004313	Water bath, 28L, with acrylic cover	1

Heating mantles with built-in controller

- Metal cased heating mantles with a unique airflow keeping the exterior cool to the touch
- Doubled fused and earthed screen
- Heating element cartridges are replaceable
- No external controllers are needed
- 'Heater On' and 'Power-On' lights
- Maximum element temperature of 450°C



Cat. No	Flask capacity, mL	Power, W	Pack qty
12654990	50	50	1
12624940	100	80	1
12611520	250	150	1
12634900	500	260	1
12661470	1,000	350	1

† GHS HAZARD INFORMATION

Classification of substances and mixtures (Regulation (EC) no. 1272/2008)

Cat. No 10562595, 10235203, 10502605

Description Acrylamide white crystals

• Health hazards

- Acute oral toxicity, category 3
- Acute dermal toxicity, category 4
- Acute inhalation toxicity (dusts and mists), category 4
- Skin corrosion/irritation, category 2
- Serious eye damage/eye irritation, category 2
- Skin sensitisation, category 1
- Germ cell mutagenicity, category 1B
- Carcinogenicity, category 1B
- Reproductive toxicity, category 2
- Specific target organ systemic toxicity (repeated exposure), category 1

Cat. No 10689923, 10689733

Description Bis-acrylamide DNase, RNase and protease free

• Health hazards

- Acute oral toxicity, category 4
- Acute dermal toxicity, category 4
- Acute inhalation toxicity (dusts and mists), category 4
- Skin corrosion/irritation, category 2
- Serious eye damage/eye irritation, category 2
- Specific target organ toxicity (single exposure), category 3

Cat. No 10688963

Description Acrylamide solution 40% DNase, RNase protease free, electrophoresis tested

• Health hazards

- Acute oral toxicity, category 3
- Acute dermal toxicity, category 4
- Acute inhalation toxicity (vapours), category 4
- Skin corrosion/irritation, category 2
- Serious eye damage/eye irritation, category 2
- Skin sensitisation, category 1
- Germ cell mutagenicity, category 1B
- Carcinogenicity, category 1B
- Reproductive toxicity, category 2
- Specific target organ toxicity (repeated exposure), category 1

Cat. No 10081503, 10396503

Description Ammonium persulfate crystals

• Physical hazards

- Oxidizing solids, category 3

• Health hazards

- Acute oral toxicity, category 4
- Skin corrosion/irritation, category 2
- Serious eye damage/eye irritation, category 2
- Respiratory sensitisation, category 1
- Skin sensitisation, category 1
- Specific target organ toxicity (single exposure), category 3

Cat. No 11423094

Description Sodium persulfate >98% white crystalline powder

• Physical hazards

- Oxidizing solids, category 3

• Health hazards

- Acute oral toxicity, category 4
- Skin corrosion/irritation, category 2
- Serious eye damage/eye irritation, category 2
- Respiratory sensitisation, category 1
- Skin sensitisation, category 1
- Specific target organ toxicity (single exposure), category 3

Cat. No 10689543, 10142863

Description TEMED (N,N,N',N'-Tetramethylethylenediamine) electrophoresis tested

• Physical hazards

- Flammable liquids, category 2

• Health hazards

- Acute oral toxicity, category 4
- Acute inhalation toxicity (vapours), category 4
- Skin corrosion/irritation, category 1B
- Serious eye damage/eye irritation, category 1

Cat. No 10102913, 10254583

Description Triton X-100

• Health hazards

- Acute oral toxicity, category 4
- Serious eye damage/eye irritation, category 1
- Chronic aquatic toxicity, category 3

Cat. No 10659163, 10274723

Description CHAPS

• Health hazards

- Skin corrosion/irritation, category 2
- Serious eye damage/eye irritation, category 2
- Specific target organ systemic toxicity (single exposure), category 3

Cat. No 10366553

Description Brij 35

• Health hazards

- Acute oral toxicity, category 4
- Skin corrosion/irritation, category 2
- Serious eye damage/eye irritation, category 1

Cat. No 10265153, 10552785

Description Sodium dodecyl sulfate (SDS) solution 10% DNase, RNase and protease free for molecular biology

• Health hazards

- Skin corrosion/irritation, category 2
- Serious eye damage/eye irritation, category 2
- Specific target organ toxicity (single exposure), category 3

Cat. No 10607633, 10607443

Description Sodium dodecyl sulfate (SDS) solution 20% DNase, RNase and protease free, for molecular biology

• Health hazards

- Skin corrosion/irritation, category 2
- Serious eye damage/eye irritation, category 2
- Specific target organ toxicity (single exposure), category 3

Cat. No 10522595, 10011083

Description Boric acid electrophoresis tested, DNase free

• Health hazards

- Reproductive toxicity, category 1B

Cat. No 10618973, 10522965

Description EDTA, disodium salt, dehydrate

• Health hazards

- Acute inhalation toxicity (dusts and mists), category 4

Cat. No 10234673, 10234723

Description MOPS biological buffer DNase, RNase and protease free

• Health hazards

- Skin corrosion/irritation, category 2
- Serious eye damage/eye irritation, category 2
- Specific target organ systemic toxicity (single exposure), category 3

Cat. No 10532965

Description Xylene cyanol FF

• Health hazards

- Skin corrosion/irritation, category 2
- Serious eye damage/eye irritation, category 2
- Specific target organ systemic toxicity (single exposure), category 3

Cat. No 10132863

Description Ethidium bromide solution 1%

• Health hazards

- Acute inhalation toxicity (dusts and mists), category 3
- Germ cell mutagenicity, category 2

Cat. No 10726074, 10678973

Description Ethidium bromide

• Health hazards

- Acute oral toxicity, category 4
- Acute inhalation toxicity (vapours), category 2
- Germ cell mutagenicity, category 2

Cat. No 10021123

Description Acetic acid glacial

• Physical hazards

- Flammable liquids, category 3

• Health hazards

- Skin corrosion/irritation, category 1A

Cat. No 10447450

Description Hydrochloric acid solution 2M (2N)

• Health hazards

- Substances/mixtures corrosive to metal, category 1

Cat. No 10366313

Description β-Mercaptoethanol

• Health hazards

- Acute oral toxicity, category 4
- Acute dermal toxicity, category 3
- Skin corrosion/irritation, category 2
- Serious eye damage/eye irritation, category 2
- Specific target organ systemic toxicity (single exposure), category 3
- Chronic aquatic toxicity, category 2

For further information Safety Data Sheets are available from www.eu.fishersci.com

Fisherbrand[®]
QUALITY. RELIABILITY. VALUE.

Fisherbrand Focus

Whatever your application Fisherbrand has a solution for you



In the United Kingdom:
For customer service, call 01509 555000
To fax an order, use 01509 555111
To order online: www.fisher.co.uk

 **Fisher
Scientific**

A Thermo Fisher Scientific Brand